



swiss bed concept



MOVIE-/TOP LINE

Achten Sie auf FSC®-zertifizierte Produkte | Soyez attentifs aux produits certifiés FSC® | Look for FSC®-certified products



Hasena – mein Bett

Hasena – mon lit | Hasena – my bed

Beständige Passion

Une passion constante
Enduring Passion



Mehr als ein Lebenswerk

Als Familienunternehmen gegründet, überzeugen wir seit über 70 Jahren mit hoher Qualität und Vielseitigkeit im Bereich Schlafzimmermöbel.

Plus que l'œuvre d'une vie

Fondée en tant qu'entreprise familiale, nous convainquons depuis plus de 70 ans par notre qualité élevée et notre polyvalence dans le domaine des meubles de chambre à coucher.

More than a life's work

Founded as a family business, we have been impressing with high quality and versatility in the field of bedroom furniture for over 70 years.

swiss bed concept



swiss bed concept

Ein cleveres Baukastensystem

Sie wählen Ihren favorisierten Bettrahmen aus und kombinieren dazu Füße und Kopfteil Ihrer Wahl. Dabei können Sie quer durch die Kollektionen auf unterschiedliche Materialien und Farben zugreifen.

Un système modulaire astucieux

Vous choisissez votre cadre de lit préféré et le combinez avec les pieds et les têtes de lit de votre choix. Vous pouvez choisir parmi une variété de matériaux et de couleurs dans toutes les collections.

A clever modular system

You choose your favourite bed frame and combine it with the feet and headboards of your choice. You can choose from a variety of materials and colours throughout the collections.

5 Jahre Garantie

Service de livraison rapide
5 years warranty



Unser Versprechen

Vom Baum zum Bett – mittels handwerklicher Perfektion und hochwertigen Materialien. Sie erhalten 5 Jahre Garantie auf die Material- und Oberflächenbeschaffenheit, sowie die fachgerechte Verarbeitung aller Modelle ab Kaufdatum. Weitere Informationen finden Sie auf unserer Website.

Notre promesse

De l'arbre au lit – grâce à un artisanat parfait et des matériaux de haute qualité. Vous bénéficiez d'une garantie de 5 ans sur la qualité des matériaux et des surfaces, ainsi que sur la fabrication professionnelle de tous les modèles à compter de la date d'achat. Vous trouverez plus d'informations sur notre site Internet.

Our promise

From tree to bed – by means of perfect craftsmanship and high-quality materials. You receive a 5-year guarantee on the material and surface quality, as well as the professional workmanship of all models from the date of purchase. Further information can be found on our website.

Schnellieferservice

Service de livraison rapide
Quick delivery service



Komfort ohne Wartezeit

Mit unserem Schnellieferservice «PRONTO» können wir eine grosse Auswahl an Betten mit Beimöbeln und alle Modelle aus Edition pronto, Dream pronto und Boxspring pronto ab Lager liefern.

Le confort sans attente

Notre service de livraison rapide « PRONTO » permet de livrer un large choix de lits, de meubles d'appoint et tous les modèles de l'Édition Pronto, Dream pronto et Boxspring Pronto à partir du stock.

Comfort without waiting

With our quick delivery service «PRONTO» we can offer a large selection of beds with ancillary furniture and all models from models from Edition pronto, Dream pronto and Boxspring pronto from stock.





Vielseitig kombinierbar

Unser ausgeklügeltes Baukastensystem «swiss bed concept» bietet eine riesige Auswahl an Füßen, Kopfteilen und Beimöbeln. Darüber hinaus umfasst es verschiedene Stoff-, Kunstleder- und Lederbezüge sowie diverse Holz- und Metallausführungen. Abgestimmte Lattenroste und Matratzen komplettieren unsere Betten zur Wohlfühloase.

Combinable à versatile

Notre système modulaire sophistiqué «swiss bed concept» propose un choix énorme de pieds, têtes de lits et accessoires. Par ailleurs le comporte différents tissus, cuirs synthétiques et véritables, ainsi que diverses variantes de bois et métal. Des sommiers à lattes et des matelas adaptés complètent nos lits pour un espace bien-être.

Versatile combinable

Our ingenious modular system «swiss bed concept» offers a huge selection of feet, headboards and accessories. In addition, it includes different fabrics, synthetic leather and real leather covers and different wood and metal versions. Matching slatted frames and mattresses complete our beds to an oasis of well-being.

Nachhaltigkeit bei Hasena

Unser wichtigster Lieferant, die Natur, ist sensibel und benötigt lange Regenerationszeiten bei Überbeanspruchung. Wir respektieren die von uns genutzten Ökosysteme und stellen unsere Produkte nachhaltig und mit hohem sozialen Engagement her.



Soziale Verantwortung

Responsabilité sociale
Social responsibility



Holzoberflächen

Surfaces en bois
Wood surfaces



Stabil im Aufbau

Unsere Betten überzeugen durch eine hohe Stabilität. Mittels Einsatz verschiedener Traversen ist eine gesamthafte Belastung von 300 bis 450 kg, inklusive Lattenroste und Matratzen, möglich.

Construction robuste

Nos lits sont convainçants par leur grande stabilité. En utilisant différentes fermes, une charge totale de 300 à 450 kg, y compris les sommiers à lattes et les matelas, est possible.

Solid in construction

Our beds convince with their high stability. By using different trusses, a total load of 300 to 450 kg, including slatted frames and mattresses, is possible.

Durabilité chez Hasena

Notre fournisseur le plus important, la nature, est sensible et nécessite un long temps de régénération en cas de surutilisation. Nous respectons les écosystèmes que nous utilisons et fabriquons nos produits de manière durable et avec un haut niveau d'engagement social.



Holzbeschaffung

Approvisionnement en bois
Wood procurement



Recycelte Stoffe

Tissus recyclés
Recycled fabrics



Einfach in der Montage

Unser Betten-System begeistert durch einen einfachen Aufbau mit leicht verständlicher Montageanleitung sowie hochwertigen Verbindungselementen, welche einen vielfachen Ab- und Wiederaufbau ermöglichen.

Montage facile

Notre système de lits séduit par une installation facile grâce aux instructions de montage bien compréhensibles ainsi que par les éléments de fixation haut de gamme permettant de monter et démonter les lits à de nombreuses reprises.

Solid in construction

Our beds convince with their high stability. By using different trusses, a total load of 300 to 450 kg, including slatted frames and mattresses, is possible.

Sustainability at Hasena

Our most important supplier, nature, is sensitive and needs long regeneration times in case of overuse. We respect the ecosystems we use and manufacture our products sustainably and with a high level of social commitment.



Produktion Massivholz

Production bois massif
Manufacturing solid wood



Energiegewinnung

Production énergétique
Production of energy



Bettrahmen | Cadre de lit | Bedframe



Star 16 Movie-Line



Breiten | Largeurs | Widths:
90, 100, 120, 140, 160, 180, 200 cm

Längen | Longueurs | Lengths:
190, 200, 210, 220 cm

Einlegetiefe | Hauteur encastrable | Insertion depth:
16 cm

Advance 18 Top-Line



Breiten | Largeurs | Widths:
90, 100, 120, 140, 160, 180, 200 cm

Längen | Longueurs | Lengths:
190, 200, 210, 220 cm

Einlegetiefe | Hauteur encastrable | Insertion depth:
18 cm

Bettrahmen MDF ummantelt in unten genannten Ausführungen. Die Holzstrukturen sind Nachbildungen. Gehrungsteile in alu und chrom inklusive.

Cadre de lit en MDF dans les exécutions ci-dessous. Les structures en bois sont laminées. Angles décoratifs en alu et chrome inclus.

Bedframe in MDF in below mentioned executions. All wooden structures are laminated. Deco corners in alu and chrome are included.

Ausführungen | Exécutions | Executions

Holz | Bois | Wood

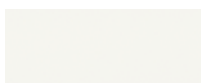

10
Weiss
Blanc
White



16
Anthracit

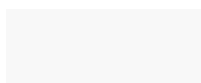

35
Hochglanz weiss
Blanc brillant
White highgloss



49
Beton Nachbildung
Béton laminé
Concrete laminated



50
Eiche sägerauh natur
Chêne brut de sciage naturel
Oak rough sawn natural

Traversen | Traverses | Bars

Wir empfehlen grundsätzlich den Einsatz von Crosstraver (Quertraverse) oder Midtraver (Längstraverse).

Nous recommandons en général l'utilisation de Crosstraver (traverse transversale) ou Midtraver (traverse centrale).

We recommend basically the insertion of Crosstraver (central cross bar) or Midtraver (central bar).

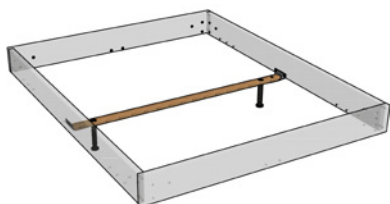

Crosstraver

Quertraverse | Traverse transversale | Central cross bar

Für alle Bettbreiten | Pour toutes les largeurs de lit | For all bed widths

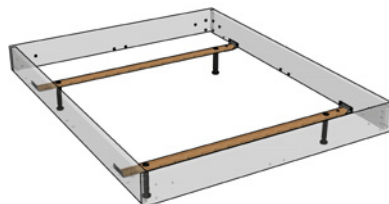

Crosstraver-Twin

Quertraversen | Traverses transversales | Cross bars

Für alle Bettbreiten | Pour toutes les largeurs de lit | For all bed widths

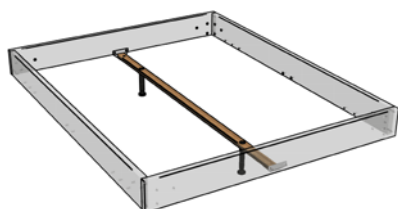

Midtraver

Längstraverse | Traverse centrale | Central bar

Für Betten ab Breite 140 cm mit 2 Lattenrosten oder Motorrahmen-einbau | Pour les lits à partir de 140 cm de largeur avec 2 sommiers ou l'installation d'un cadre motorisé | For beds from 140 cm width with 2 slats or motor frame installation

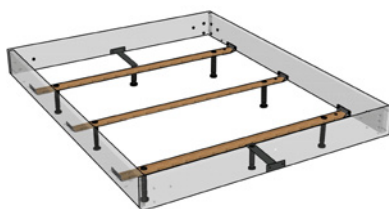

Crosstraver-XXL

Quertraversen | Traverses transversales | Cross bars

Für alle Bettbreiten | Pour toutes les largeurs de lit | For all bed widths

Übersicht Kompatibilität Traversen siehe Gesamtkatalog Seite 2.12 | Aperçu compatibilité traverses voir catalogue général page 2.12 | Overview compatibility bars see general catalogue page 2.12

Das Bettsystem der unbegrenzten Möglichkeiten

Die Betten unserer Movie-Line und Top-Line sind in zahlreichen Variationen erhältlich. Mit ihrem jugendlichen Esprit und den Bettrahmen-Höhen von 16 und 18 cm verleihen sie jedem Schlafzimmer einen frischen Charakter und ermöglichen ein Einrichten ganz nach Ihren Wünschen. Die höheren Bettrahmen punkten durch den Einsatz von höheren Matratzen und einer grösseren Einlegetiefe.

- 7 Breiten
- 4 Längen
- Spezialgrößen
- Star- und Advance-Bettrahmen in 5 Farben
- Bettrahmen MDF ummantelt, Holzstrukturen sind Nachbildungen
- Gehrungsteile in Alu und Chrom inklusive
- grosse Auswahl an Fussvarianten, Kopfteilen und Wandpaneelen
- Füße in Komforthöhen erhältlich
- perfekt passende Beimöbel

Le système de lit des possibilités illimitées

Les lits de notre gamme Movie-Line et Top-Line sont disponibles en de nombreuses variantes. Avec leur esprit jeune et leurs hauteurs de cadre de lit de 14 et 16 cm, ils donnent à chaque chambre un caractère frais et permettent de l'aménager selon vos souhaits. Les cadres de lit plus hauts marquent des points grâce à l'utilisation de matelas plus épais et à une plus grande profondeur d'insertion.

- 7 largeurs
- 4 longueurs
- Dimensions spéciales
- Cadre de lit Star et Advance en 5 couleurs
- Cadre du lit en mdf, les structures en bois sont laminées
- Angles décoratifs en alu et chrome inclus
- grand choix de variantes de pieds têtes de lit et panneaux muraux
- Pieds disponibles en hauteurs de confort
- Meubles d'appoint parfaitement assortis

The bed system of the unlimited possibilities

The beds of our Movie- and Top-Line are available in numerous variations. With their youthful esprit and bed frame heights of 14 and 16 cm, they give every bedroom a fresh character and make it possible to furnish it according to your wishes. The higher bed frames score points through the use of higher mattresses and a greater insertion depth.

- 7 widths
- 4 lengths
- Special sizes
- Star and Advance bed frames in 5 colours
- Bedframe in mdf, all wooden structures are laminated
- Deco corners in alu and chrome are included
- large selection of foot variations, headboards and wall panels
- Feet available in comfort heights
- perfectly matching side furniture

Füsse | Pieds | Feet



Holz | Bois | Wood

Cantu



Juve 



Masi 



Evio 



Vilo 



Lovie-Box 

90–140 (1 Schublade/Tiroir/Drawer)

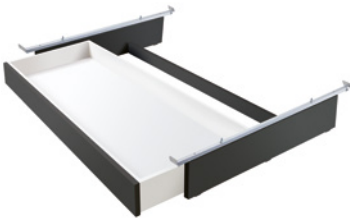

Lovie-Box 

140–200 (2 Schubladen/Tiroirs/Drawers)



Practico-Box 



Holz | Bois | Wood

	Masse cm Dimensions cm	Breiten cm Largeurs cm Widths cm	Höhen cm Hauteurs cm Heights cm				Holzfarben Couleurs bois Colours wood		
			10	20	25	30	10	16	50
Cantu	8×8			●	●	●	●		●
Evio		90–200			●		●		
Juve	6–8×6–8			●	●		●		
Lovie-Box (1 Schublade/Tiroir/Drawer)		90–140			●		●		
Lovie-Box (2 Schubladen/Tiroirs/Drawers)		140–200			●		●		
Masi	6×4			●	●		●		
Practico-Box (inkl. Boden Fond inclus Bottom included)		90–200			●		●		
Vilo		90–200		●			●		

Practico-Box aus MDF ummantelt. Holzfüsse sind aus Massivholz | Practico-Box en mdf laminé. Pieds en bois massif | Practico-Box in mdf coated. Wooden feet are of solid wood.

Ausführungen | Exécutions | Executions

Holz | Bois | Wood



10
Buche weiss
deckend, lackiert
Hêtre blanc couvrant,
laqué
Beech white
covered, lacquered



16
Buche anthracit
deckend, lackiert
Hêtre anthracite
couvrant, laqué
Beech anthracit
covered, lacquered



50
Eiche sägerauh natur
Chêne brut de sciage naturel
Oak rough sawn natural

Füsse | Pieds | Feet

Metall | Métal | Metal

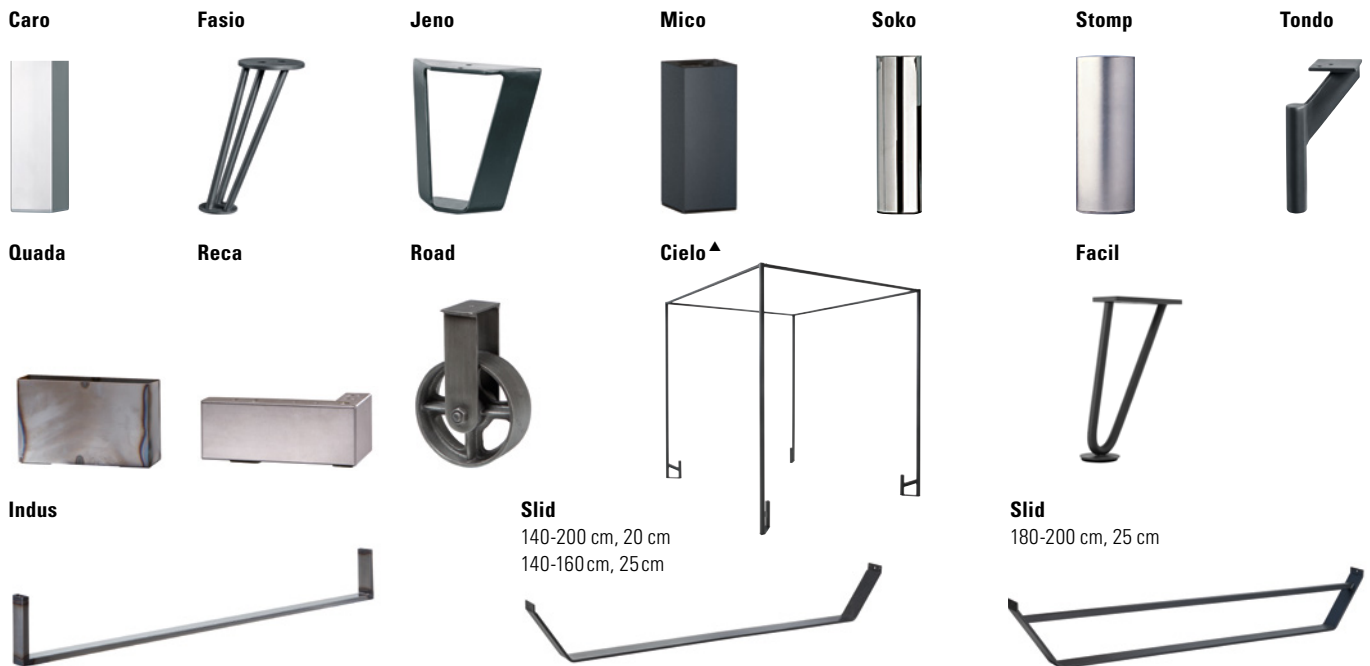

Metall | Métal | Metal

	Masse cm Dimensions cm	Breiten cm Largeurs cm Widths cm	Höhen cm Hauteurs cm Heights cm				Metallfarben Couleurs métal Colours metal						Hochglanz Brillant Highgloss			
			10	20	25	30	00	04	10	16	40	41		42	43	45
Caro	6×6			●	●		●					●				
Cielo [▲]		120–200		●				●								
Facil				●					●							
Fasio	∅5/9			●					●	●						
Indus	6×2	140–200		●	●				●					●		
Jeno	12×5		●	●	●			●								
Mico	8×8		●	●	●	●		●				●	●	●		●
Quada	20×6,5			●	●											●
Reca	24×12		●										●			
Road*	∅13			●					●							
Slid	8/1	140–200		●	●				●					●		
Soko	∅6			●	●			●						●		
Stomp	∅8		●	●	●	●		●						●		
Tondo	∅3,5			●					●					●		

*Füsse fixiert, Rollen nur optisch | Pieds fixes, roulettes uniquement décoratives | Feet fixed, castors only visual

[▲] Curty Vorhang und Vela Baldachin-Tuch siehe Gesamtkatalog Register 2, Seite 2.12 | Curty rideau et Vela tissu de baldachin voir catalogue général registre 2, page 2.12 | Curty curtain and Vela canopy cloth see general catalogue index 2, page 2.12

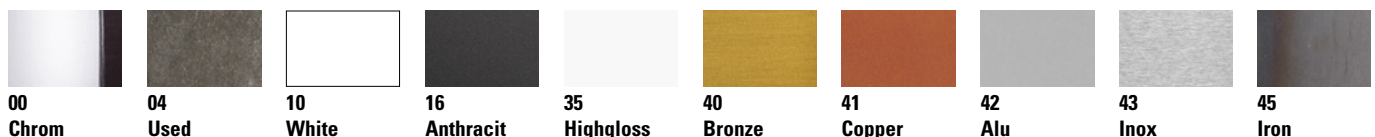

00 Chrom = Edelstahl poliert | Acier poliit | Stainless steel polished
 04 Used = Stahl galvanisiert | Acier galvanisé | Steel galvanised
 10 White = Stahl pulverbeschichtet | Acier thermolaqué | Steel powder-coated
 16 Anthracit = Stahl pulverbeschichtet | Acier thermolaqué | Steel powder-coated
 40 Bronze = Stahl lackiert | Acier laqué | Steel lacquered

41 Copper = Stahl lackiert | Acier laqué | Steel lacquered
 42 Alu = Stahl pulverbeschichtet | Acier thermolaqué | Steel powder-coated
 43 Inox = Edelstahl geschliffen | Acier poncé | Stainless steel ground
 45 Iron = Stahl geflammt, pulverbeschichtet | Acier flammé, thermolaqué | Steel mottled, powder-coated

Kopfteile | Têtes de lit | Headboards



Nuetta 

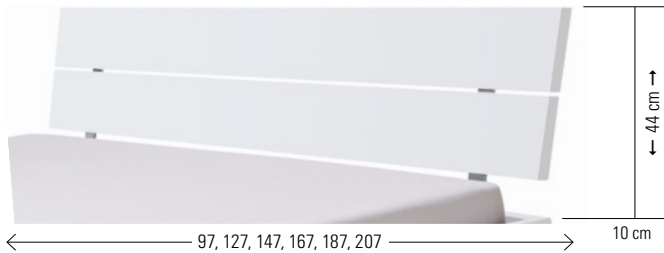

Dimension: 90/100, 120, 140, 160, 180, 200

Nia 

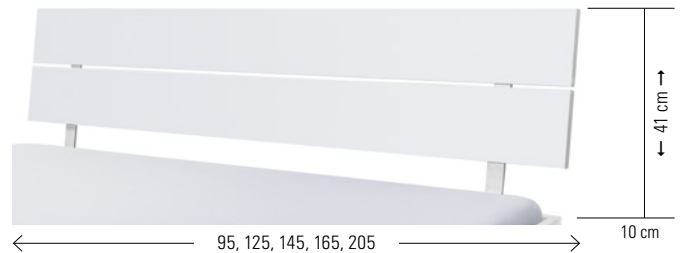

Dimension: 90/100, 120, 140, 160, 180/200

Orva 

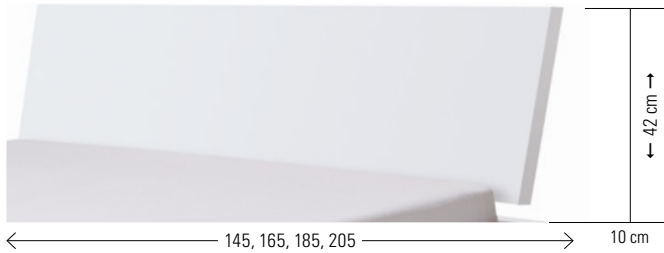

Dimension: 140, 160, 180, 200



Gepolsterte Kopfteile, Wandpaneele, Stoffauswahl/Farben siehe Gesamtkatalog Register 1, Seite 1.6 – 1.7, Leselampen siehe Gesamtkatalog Register 2, Seite 2.12

Têtes de lits rembourrées, panneaux muraux, choix de tissus/couleurs voir catalogue général registre 1, pages 1.6 – 1.7, lampes de lecture voir catalogue général registre 2, page 2.12
Upholstered headboards, wallpanels, choice of tissues/colours see general catalogue index 1, pages 1.6 – 1.7, reading lamps see general catalogue index 2, page 2.12

Holz | Bois | Wood

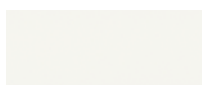

10 Weiss
Blanc
White



16 Anthracit

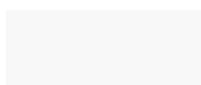

35 Hochglanz weiss
Blanc brillant
White highgloss



49 Beton Nachbildung
Béton laminé
Concrete laminated



50 Eiche sägerauh natur
Chêne brut de sciage naturel
Oak rough sawn natural

Die Holzstrukturen sind Nachbildungen

Les structures bois sont en bois laminé

The wood structures are laminated

Kissen zu Kopfteilen | Coussins pour têtes de lit | Cushions for headboards

Arona + Nuetta



Ravo + Orva



Varo + Orva



Lumo + Nia



Suny + Orva



Befestigung mit 2 Bändern (Klettverschluss)

Fixation avec 2 bandes (Velcro®)

Fixation with 2 ribbons (Velcro®fastener)

Stoffauswahl/Farben für Kissen siehe Gesamtkatalog Register 1, Seiten 1.6–1.7

Choix de tissus/couleurs pour coussins voir catalogue général registre 1, pages 1.6–1.7

Choice of tissues/colours for cushions see general catalogue index 1, pages 1.6–1.7

Kissen | Coussins | Cushions

Effektive Masse cm

Dimensions effectives cm
Effective dimensions cm

Arona	86, 116, 136, 156, 176×3,5×25
Lumo	86, 116, 136, 156, 176×6×25
Ravo	80, 110, 130, 150, 170, 190×3,5×35
Suny (2er Set set de 2 set of 2)	55×5×40
Varo (2er Set set de 2 set of 2)	55×10×35

zu Kopfteilen

pour têtes de lit
for headboards

Nuetta	Nia	Orva
●	●	
●	●	
●	●	●
●	●	●
		●

Breitenmasse cm

Dimensions de largeur cm
Widths dimensions cm

90/100, 120, 140, 160, 180/200
90/100, 120, 140, 160, 180/200
90/100, 120, 140, 160, 180, 200

Alle Kissen in Echtleder haben Zier- sowie Teilungsnähte. Ausnahmen: Suny und Varo, diese Kissen haben lediglich Ziernähte. | Tous les coussins en cuir véritable ont des coutures décoratives et des coutures de séparation. A l'exception des coussins : Suny et Varo, ces coussins ont uniquement des coutures décoratives. | All cushions in genuine leather have decorative and dividing seams. Exceptions: Suny and Varo, these cushions only have decorative seams.

Adapter | Adaptateur | Adapter

Bei hohen Matratzen kann mit dem Verlängerungsadapter das Kopfteil um 9 oder 13 cm erhöht werden.

La tête de lit peut être rehaussée de 9 ou 13 cm avec l'adaptateur lorsque le matelas est plus épais.

With the extension adapter the headboard can be extended 9 or 13 cm if mattresses are high.

Head-Plus Metall | Métal | Metal



alu

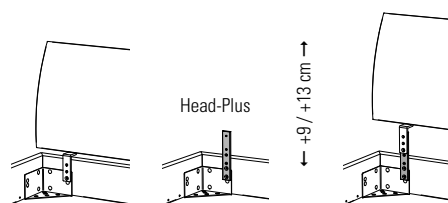

selezione

01

MODELLAUSWAHL

Sélection du modèle | Model selection

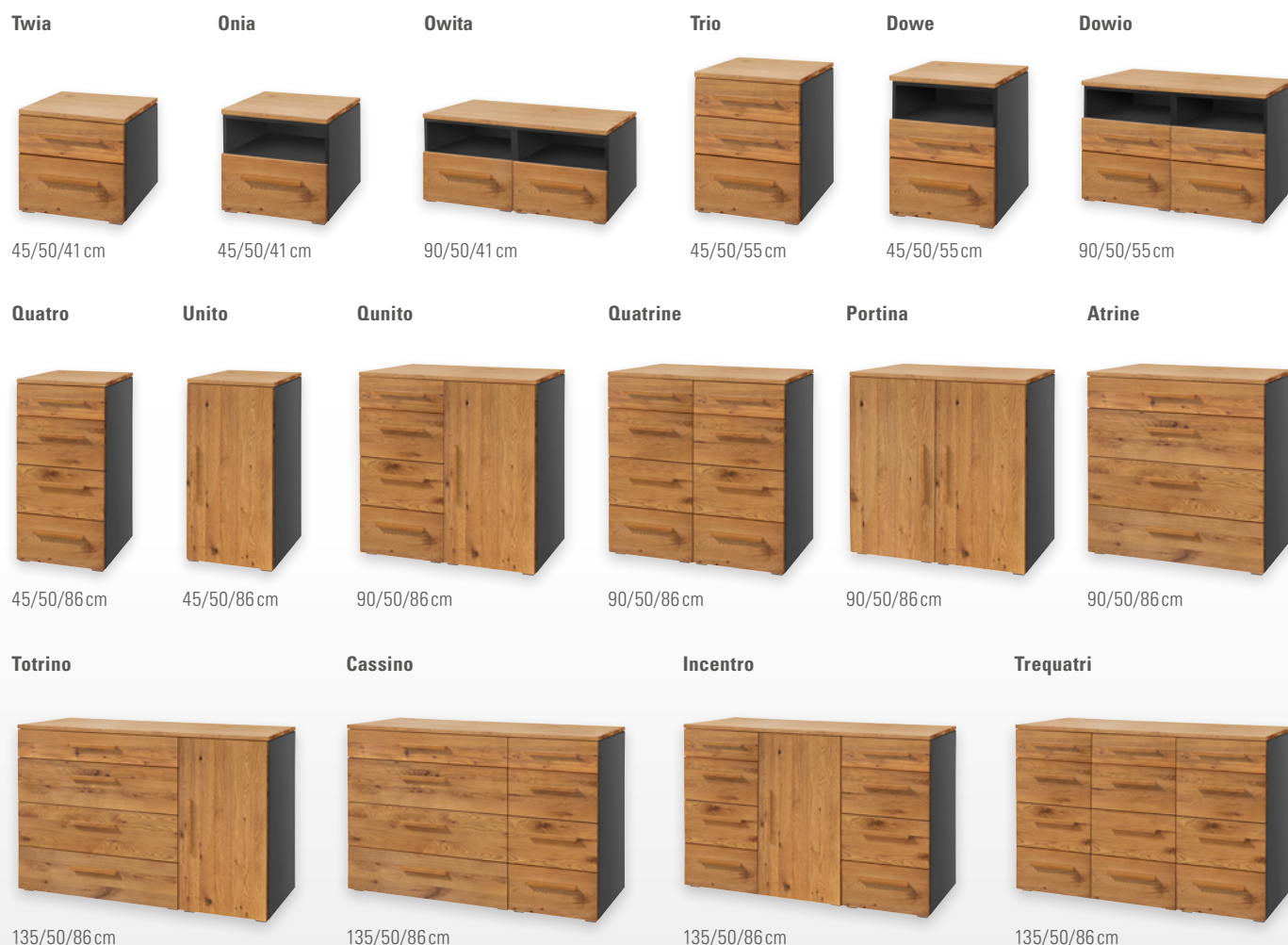
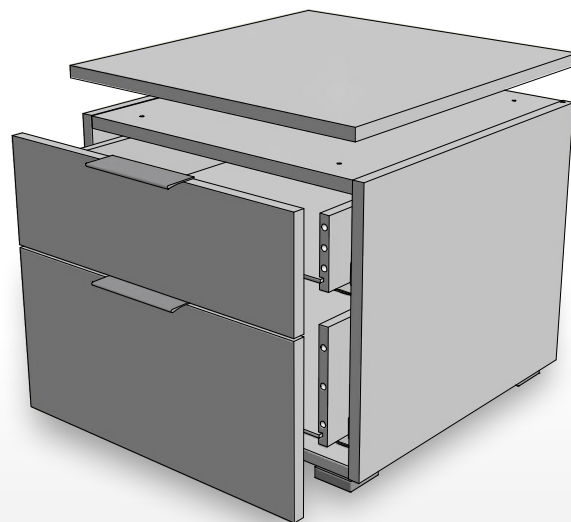

Stellen Sie sich Ihr Wunsch-Beimöbel nach Ihrem Geschmack zusammen: Der Korpus (Abb. 02), in zwei verschiedenen Farbvarianten, lässt sich zu den Front- und Top-Covern (Abb. 03) in acht Holz- und Farbausführungen kombinieren. Die Beimöbel können zerlegt oder teilmontiert bestellt werden. Bei zusammengesetzten Möbeln (z. B. Qunito, Incentro, ...) muss der Deckel noch montiert werden. Bei Kommoden mit Türen ist jeweils ein Einlegeboden vorhanden, Türöffnung nach links oder rechts möglich. Zusätzliche Böden sind erhältlich.

Composez le meuble d'appoint de vos rêves selon vos goûts : Le caisson (ill. 02), disponible en 2 variantes de couleurs, peut être combiné avec les façades et couvercles supérieurs (ill. 03) en 8 finitions de bois et de coloris. Les meubles d'appoint peuvent être commandés en kits ou assemblés. Pour les meubles assemblés (p. ex. Qunito, Incentro, ...) le couvercle doit encore être fixé. Les commodes avec portes sont équipées d'une étagère, ouverture de la porte possible à gauche ou à droite. Si besoin, des étagères supplémentaires sont disponibles.

Put together the side furniture you want according to your own taste: The body (fig. 02), in two different colour versions, can be combined with the front and top covers (fig. 03) in eight wood and colour versions. The furniture can be ordered disassembled or assembled. For assembled furniture (e.g. Qunito, Incentro, ...) the top cover must still be fitted. Chests of drawers with doors have one shelf, door opening possible to the left or right. Additional shelves are available.



Kombinationsbeispiele und techn. Informationen
Exemples et informations
Examples and informations

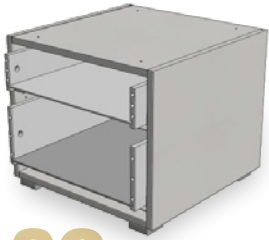

02

KORPUS

Caisson | Body



03

TOP/FRONT

Farben | Couleurs | Colours

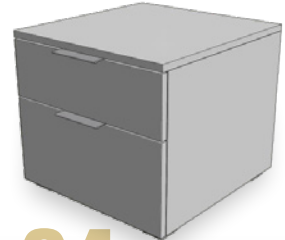

04

GRIFFE

Poignées | Handles



10 Weiss | Blanc | White



16 Anthracit | Anthracite



FÜSSE

Pieds | Feet

STANDARD



OPTION

Leg 8 cm

Jone 10 cm

Cila 10 cm



alu



anthracit
used



anthracit



10 Weiss | Blanc | White



16 Anthracit | Anthracite

STANDARD



Alu

Griff zu Folienfronten

Poignée pour façades en mélaminé
Handle for foil fronts

STANDARD



Holzgriff zu Holzfronten

Poignée en bois pour façades en bois
Wooden handle for wooden fronts

OPTION

Rivo



Used



Anthracit

Metallgriff zu Holzfronten

Poignée en métal pour façades en bois
Metal handle for wooden fronts

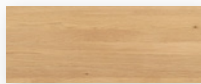

74 Eiche bright, geölt
Chêne bright, huilé
Oak bright, oiled

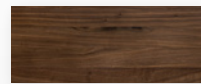

82 Nussbaum, geölt
Noyer, huilé
Walnut, oiled

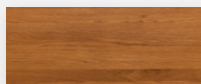

76 Eiche brandy, geölt
Chêne brandy, huilé
Oak brandy, oiled



87 Wildbuche natur, geölt
Hêtre nouveau naturel, huilé
Wildbeech natural, oiled



80 Kernbuche natur, geölt
Hêtre coeur rouge
naturel, huilé
Heart beech natural, oiled

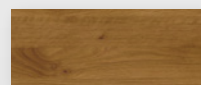

99 Wildeiche natur, geölt
Chêne nouveau naturel, huilé
Wildoak natural, oiled



The mark of
responsible forestry
FSC® C123546

Look for FSC® certified products



				Dimension cm
Twia	Nachttisch	Table de nuit	Bedside table	45/49/40
Atrine	Kommode	Commode	Chest of drawers	90/49/85

Alle Holzteile in Hochglanz weiss oder weiss | Toutes les parties en bois en blanc brillant ou blanc | All wooden parts in white highgloss or white
Weitere Beimöbel siehe Gesamtkatalog Register 2 | Autres accessoires voir catalogue général registre 2 | Further accessories see general catalogue index 2

Star 16



				Dimension cm
Star 16	Rahmen Breiten Längen	Cadre Largeurs Longueurs	Frame Widths Lengths	140, 160, 180, 200 190, 200, 210, 220
Mico chrom	Füße Höhen	Pieds Hauteurs	Feet Heights	10, 20, 25, 30
Orva Varo	Kopfteil Kissen (2er Set) Alpina lightgrey 390	Tête de lit Coussins (set de 2) Alpina lightgrey 390	Headboard Cushions (set of 2) Alpina lightgrey 390	140, 160, 180, 200 55/10/35

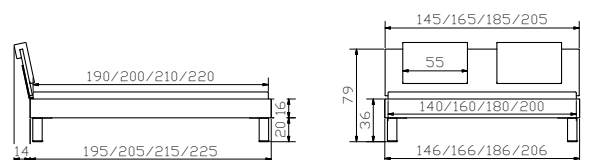



Onia	Nachttisch	Table de nuit	Bedside table	Dimension cm 45/49/40
-------------	------------	---------------	---------------	---------------------------------

Alle Holzteile in Beton Nachbildung oder weiss | Toutes les parties en bois en béton laminé ou blanc | All wooden parts in concrete laminated or white
Weitere Beimöbel siehe Gesamtkatalog Register 2 | Autres accessoires voir catalogue général registre 2 | Further accessories see general catalogue index 2



				Dimension cm
Star 16	Rahmen Breiten Längen	Cadre Largeurs Longueurs	Frame Widths Lengths	90, 100, 120, 140, 160, 180, 200 190, 200, 210, 220
Caro alu	Füße Höhen	Pieds Hauteurs	Feet Heights	20, 25
Nia	Kopfteil	Tête de lit	Headboard	90/100, 120, 140, 160, 180/200

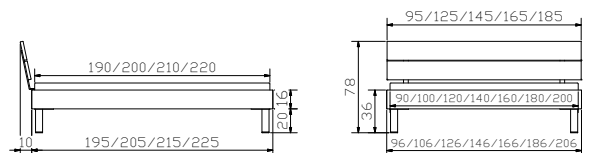



				Dimension cm
Twia	Nachttisch	Table de nuit	Bedside table	45/49/40

Alle Holzteile in weiss | Toutes les parties en bois en blanc | All wooden parts in white

Weitere Beimöbel siehe Gesamtkatalog Register 2 | Autres accessoires voir catalogue général registre 2 | Further accessories see general catalogue index 2



				Dimension cm
Star 16	Rahmen Breiten Längen	Cadre Largeurs Longueurs	Frame Widths Lengths	90, 100, 120, 140, 160, 180, 200 190, 200, 210, 220
Caro alu	Füße Höhen	Pieds Hauteurs	Feet Heights	20, 25
Nia	Kopfteil	Tête de lit	Headboard	90/100, 120, 140, 160, 180/200

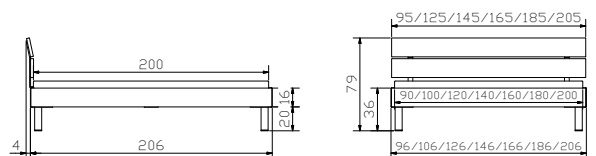



Alle Holzteile in weiss | Toutes les parties en bois en blanc | All wooden parts in white

Weitere Beimöbel siehe Gesamtkatalog Register 2 | Autres accessoires voir catalogue général registre 2 | Further accessories see general catalogue index 2

Curty

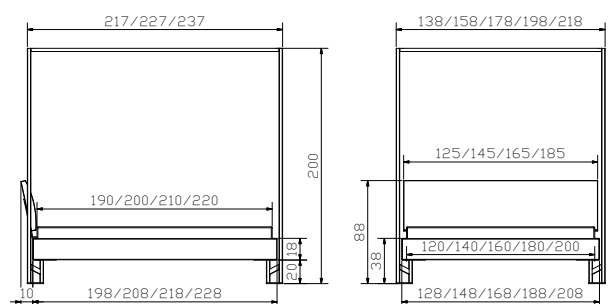

Advance 18



				Dimension cm
Advance 18	Rahmen Breiten Längen	Cadre Largeurs Longueurs	Frame Widths Lengths	120, 140, 160, 180, 200 190, 200, 210, 220
Cielo white	Baldachin Breiten Höhe	Baldaquin Largeurs Hauteur	Canopy Widths Height	120, 140, 160, 180, 200 20
Lecco	Kopfteil, Campos blanc 372 siehe Gesamtkatalog Register 1	Tête de lit, Campos blanc 372 voir catalogue général registre 1	Headboard, Campos blanc 372 see general catalogue index 1	120, 140, 160, 180/200
Vela	Baldachin-Tuch, Baumwolle weiss Breiten Länge	Tissu de baldaquin, coton blanc Largeurs Longueur	Canopy cloth, cotton white Widths Length	120, 140, 160, 180 200
Trio	Nachttisch	Table de nuit	Bedside table	45/49/55



				Dimension cm
Atrine	Kommode	Commode	Chest of drawers	90/49/85
Twia	Nachttisch	Table de nuit	Bedside table	45/49/40
Jone 10 used	Füsse Höhe	Pieds Hauteur	Feet Height	10

Alle Holzteile in weiss oder Eiche sägerauh natur | Toutes les parties en bois en blanc ou chêne brut de sciage naturel | All wooden parts in white or oak rough sawn natural

Weitere Beimöbel siehe Gesamtkatalog Register 2 | Autres accessoires voir catalogue général registre 2 | Further accessories see general catalogue index 2



				Dimension cm
Advance 18	Rahmen Breiten Längen	Cadre Largeurs Longueurs	Frame Widths Lengths	90, 100, 120, 140, 160, 180, 200 190 (200), 200 (210), 210 (220)
Jeno used	Füsse Höhen	Pieds Hauteurs	Feet Heights	10, 20, 25
Cena	Kopfteil, Campos blanc 372 hat Einfluss auf Bettlänge siehe Gesamtkatalog Register 1, Seite 4	Tête de lit, Campos blanc 372 a un impact sur la longueur du lit voir catalogue général registre, page 4	Headboard, Campos blanc 372 affects the length of bed see general catalogue index 1, page 4	90, 100, 120, 140, 160, 180, 200 90 – 120 = 1 Kissen/Coussin/ Cushion

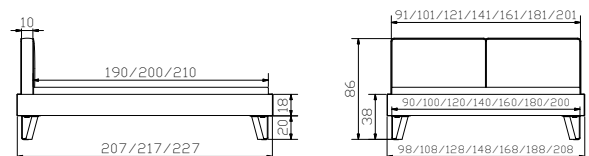



				Dimension cm
Topa anthracit	Bank inkl. Kissen Casual carbon 334	Banquette, coussin incl. Casual carbon 334	Bench, cushion incl. Casual carbon 334	144/44/38
Twia	Nachttisch	Table de nuit	Bedside table	45/49/40
Atrine	Kommode	Commode	Chest of drawers	90/49/85

Alle Holzteile in anthracit | Toutes les parties en bois en anthracite | All wooden parts in anthracite

Weitere Beimöbel siehe Gesamtkatalog Register 2 | Autres accessoires voir catalogue général registre 2 | Further accessories see general catalogue index 2



				Dimension cm
Advance 18	Rahmen Breiten Längen	Cadre Largeurs Longueurs	Frame Widths Lengths	140, 160, 180, 200 190, 200, 210, 220
Tondo anthracit	Füsse Höhe	Pieds Hauteur	Feet Height	20
Cussina	Kopfteil, Casual carbon 334 siehe Gesamtkatalog Register 1	Tête de lit, Casual carbon 334 voir catalogue général registre 1	Headboard, Casual carbon 334 see general catalogue index 1	140, 160, 180, 200

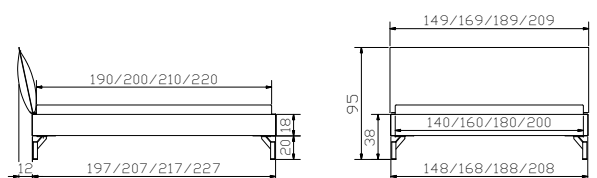



				Dimension cm
Topa anthracit	Bank inkl. Kissen Fusio musk 752	Banquette, coussin incl. Fusio musk 752	Bench, Cushion incl. Fusio musk 752	144/44/38
Twia	Nachttisch	Table de nuit	Bedside table	45/49/40

Alle Holzteile in Beton Nachbildung | Toutes les parties en bois en béton laminé | All wooden parts in concrete laminated

Weitere Beimöbel siehe Gesamtkatalog Register 2 | Autres accessoires voir catalogue général registre 2 | Further accessories see general catalogue index 2



				Dimension cm
Advance 18	Rahmen Breiten Längen	Cadre Largeurs Longueurs	Frame Widths Lengths	90, 100, 120, 140, 160, 180, 200 190, 200, 210, 220
Slid anthracit	Füße Breiten Höhen	Pieds Largeurs Hauteurs	Feet Widths Heights	140, 160, 180, 200 20, 25
Lecco	Kopfteil Fusio musk 752 siehe Gesamtkatalog Register 1	Tête de lit Fusio musk 752 voir catalogue général registre 1	Headboard Fusio musk 752 see general catalogue index 1	90/100, 120, 140, 160, 180/200

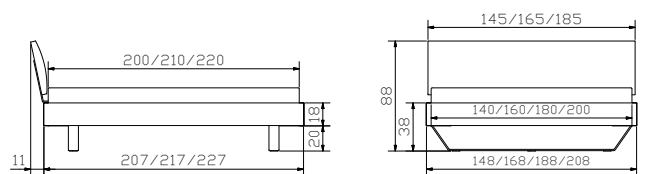



				Dimension cm
Lovie-Box	1 Bettkasten	1 Tiroir de lit	1 Bed drawer	90, 100, 120, 140
	Breiten	Largeurs	Widths	
	2 Bettkästen	2 Tiroirs de lit	2 Bed drawers	140, 160, 180, 200
	Breiten	Largeurs	Widths	
	Höhe	Hauteur	Height	25

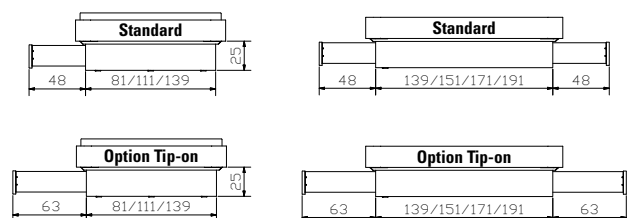



				Dimension cm
Advance 18	Rahmen Breiten Längen	Cadre Largeurs Longueurs	Frame Widths Lengths	140, 160, 180, 200 190, 200, 210, 220
Cantu	Füsse Höhen	Pieds Hauteurs	Feet Heights	20, 25, 30
Orva	Kopfteil	Tête de lit	Headboard	140, 160, 180, 200
Atrine	Kommode	Commode	Chest of drawers	90/49/85
Twia	Nachttisch	Table de nuit	Bedside table	45/49/40
Snake alu	Leselampen (2er Set) 12V DC, 6 LED 3 Beleuchtungsarten	Lampe de lecture (set de 2) 12V DC, 6 LED 3 différentes illuminations	Reading lamp (set of 2) 12V DC, 6 LED 3 different illuminations	

Alle Holzteile in Eiche sägerauh natur und weiss

Toutes les parties en bois en chêne brut de sciage naturel et blanc
All wooden parts in oak rough sawn natural and white

Leselampen und weitere Beimöbel siehe Gesamtkatalog Register 2

Lampes de lecture et autres accessoires voir catalogue général registre 2
Reading lamps and further accessories see general catalogue index 2

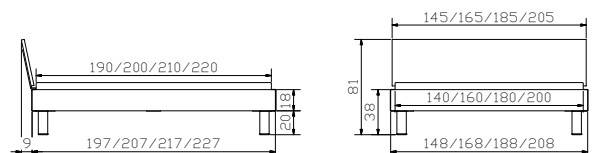



			Dimension cm
Lovie-Box	1 Bettkasten	1 Tiroir de lit	1 Bed drawer
	Breiten	Largeurs	Widths
	2 Bettkästen	2 Tiroirs de lit	2 Bed drawers
Breiten	Largeurs	Widths	90, 100, 120, 140
Höhe	Hauteur	Height	140, 160, 180, 200
			25

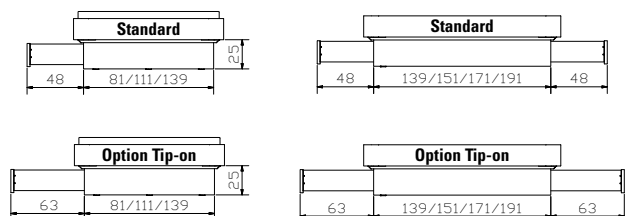



				Dimension cm
Advance 18	Rahmen Breiten Längen	Cadre Largeurs Longueurs	Frame Widths Lengths	140, 160, 180, 200 190, 200, 210, 220
Tondo anthracit	Füße Höhe	Pieds Hauteur	Feet Height	20
Talma	Kopfteil, Boucle ivory 770 siehe Gesamtkatalog Register 1	Tête de lit, Boucle ivory 770 voir catalogue général registre 1	Headboard, Boucle ivory 770 see general catalogue index 1	140, 160, 180, 200
Topa anthracit	Bank inkl. Kissen Boucle ivory 770	Banquette, coussin incl. Boucle ivory 770	Bench, cushion incl. Boucle ivory 770	144/44/38
Trio	Nachtisch	Table de nuit	Bedside table	45/49/55

Alle Holzteile in anthracit | Toutes les parties en bois en anthracite |
All wooden parts in anthracite

Weitere Beimöbel siehe Gesamtkatalog Register 2 | Autres accessoires
voir catalogue général registre 2 | Further accessories see general catalogue
index 2

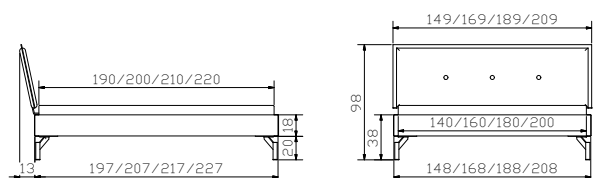



Onia anthracit

Nachttisch

Table de nuit

Bedside table

Dimension cm

45/49/40

Alle Holzteile in Beton Nachbildung | Toutes les parties en bois en béton laminé | All wooden parts in concrete laminated

Onia: anthracit | anthracite

Weitere Beimöbel siehe Gesamtkatalog Register 2 | Autres accessoires voir catalogue général registre 2 | Further accessories see general catalogue index 2



				Dimension cm
Advance 18	Rahmen Breiten Längen	Cadre Largeurs Longueurs	Frame Widths Lengths	90, 100, 120, 140, 160, 180, 200 190, 200, 210, 220
Vilo anthracit	Füße Breiten Höhe	Pieds Largeurs Hauteur	Feet Widths Height	90, 100, 120, 140, 160, 180, 200 20
Nuetta	Kopfteil	Tête de lit	Headboard	90/100, 120, 140, 160, 180, 200

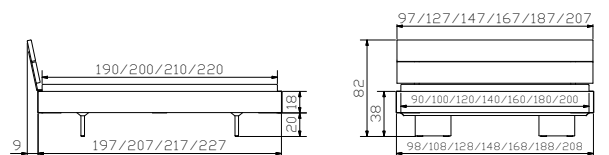



MOVIE-/TOP LINE



FACTORY LINE



WOOD LINE



LOUNGE



FINE LINE



NATURO LINE



OAK LINE



OAK WILD



DREAM LINE



**EDITION
BOXSPRING**



**FUNCTION/COMFORT
KIDS & GUESTS**



**LATTENROSTE &
MATRATZEN**



Gesamtkatalog
Catalogue général
General catalogue