



swiss bed concept



# OAKWILD ASPINO / VINTAGE BORMIO CORTINA

WILDEICHE MASSIV | CHÊNE NOUEUX MASSIF | SOLID WILDOAK





# Hasena – mein Bett

Hasena – mon lit | Hasena – my bed

## Beständige Passion

Une passion constante  
Enduring Passion



### Mehr als ein Lebenswerk

Als Familienunternehmen gegründet, überzeugen wir seit über 70 Jahren mit hoher Qualität und Vielseitigkeit im Bereich Schlafzimmermöbel.

### Plus que l'œuvre d'une vie

Fondée en tant qu'entreprise familiale, nous convainquons depuis plus de 70 ans par notre qualité élevée et notre polyvalence dans le domaine des meubles de chambre à coucher.

### More than a life's work

Founded as a family business, we have been impressing with high quality and versatility in the field of bedroom furniture for over 70 years.

## swiss bed concept



swiss bed concept

### Ein cleveres Baukastensystem

Sie wählen Ihren favorisierten Bettrahmen aus und kombinieren dazu Füße und Kopfteil Ihrer Wahl. Dabei können Sie quer durch die Kollektionen auf unterschiedliche Materialien und Farben zugreifen.

### Un système modulaire astucieux

Vous choisissez votre cadre de lit préféré et le combinez avec les pieds et les têtes de lit de votre choix. Vous pouvez choisir parmi une variété de matériaux et de couleurs dans toutes les collections.

### A clever modular system

You choose your favourite bed frame and combine it with the feet and headboards of your choice. You can choose from a variety of materials and colours throughout the collections.

## 5 Jahre Garantie

Service de livraison rapide  
5 years warranty



### Unser Versprechen

Vom Baum zum Bett – mittels handwerklicher Perfektion und hochwertigen Materialien. Sie erhalten 5 Jahre Garantie auf die Material- und Oberflächenbeschaffenheit, sowie die fachgerechte Verarbeitung aller Modelle ab Kaufdatum. Weitere Informationen finden Sie auf unserer Website.

### Notre promesse

De l'arbre au lit – grâce à un artisanat parfait et des matériaux de haute qualité. Vous bénéficiez d'une garantie de 5 ans sur la qualité des matériaux et des surfaces, ainsi que sur la fabrication professionnelle de tous les modèles à compter de la date d'achat. Vous trouverez plus d'informations sur notre site Internet.

### Our promise

From tree to bed – by means of perfect craftsmanship and high-quality materials. You receive a 5-year guarantee on the material and surface quality, as well as the professional workmanship of all models from the date of purchase. Further information can be found on our website.

## Schnellieferservice

Service de livraison rapide  
Quick delivery service



### Komfort ohne Wartezeit

Mit unserem Schnellieferservice «PRONTO» können wir eine grosse Auswahl an Betten mit Beimöbeln und alle Modelle aus Edition pronto, Dream pronto und Boxspring pronto ab Lager liefern.

### Le confort sans attente

Notre service de livraison rapide « PRONTO » permet de livrer un large choix de lits, de meubles d'appoint et tous les modèles de l'Édition Pronto, Dream pronto et Boxspring Pronto à partir du stock.

### Comfort without waiting

With our quick delivery service «PRONTO» we can offer a large selection of beds with ancillary furniture and all models from models from Edition pronto, Dream pronto and Boxspring pronto from stock.







## Vielseitig kombinierbar

Unser ausgeklügeltes Baukastensystem «swiss bed concept» bietet eine riesige Auswahl an Füßen, Kopfteilen und Beimöbeln. Darüber hinaus umfasst es verschiedene Stoff-, Kunstleder- und Lederbezüge sowie diverse Holz- und Metallausführungen. Abgestimmte Lattenroste und Matratzen komplettieren unsere Betten zur Wohlfühloase.

## Combinable à versatile

Notre système modulaire sophistiqué «swiss bed concept» propose un choix énorme de pieds, têtes de lits et accessoires. Par ailleurs le comporte différents tissus, cuirs synthétiques et véritables, ainsi que diverses variantes de bois et métal. Des sommiers à lattes et des matelas adaptés complètent nos lits pour un espace bien-être.

## Versatile combinable

Our ingenious modular system «swiss bed concept» offers a huge selection of feet, headboards and accessories. In addition, it includes different fabrics, synthetic leather and real leather covers and different wood and metal versions. Matching slatted frames and mattresses complete our beds to an oasis of well-being.

## Nachhaltigkeit bei Hasena

Unser wichtigster Lieferant, die Natur, ist sensibel und benötigt lange Regenerationszeiten bei Überbeanspruchung. Wir respektieren die von uns genutzten Ökosysteme und stellen unsere Produkte nachhaltig und mit hohem sozialen Engagement her.



## Soziale Verantwortung

Responsabilité sociale  
Social responsibility



## Holzoberflächen

Surfaces en bois  
Wood surfaces



## Stabil im Aufbau

Unsere Betten überzeugen durch eine hohe Stabilität. Mittels Einsatz verschiedener Traversen ist eine gesamthafte Belastung von 300 bis 450 kg, inklusive Lattenroste und Matratzen, möglich.

## Construction robuste

Nos lits sont convainçants par leur grande stabilité. En utilisant différentes fermes, une charge totale de 300 à 450 kg, y compris les sommiers à lattes et les matelas, est possible.

## Solid in construction

Our beds convince with their high stability. By using different trusses, a total load of 300 to 450 kg, including slatted frames and mattresses, is possible.

## Durabilité chez Hasena

Notre fournisseur le plus important, la nature, est sensible et nécessite un long temps de régénération en cas de surutilisation. Nous respectons les écosystèmes que nous utilisons et fabriquons nos produits de manière durable et avec un haut niveau d'engagement social.



## Holzbeschaffung

Approvisionnement en bois  
Wood procurement



## Recycelte Stoffe

Tissus recyclés  
Recycled fabrics



## Einfach in der Montage

Unser Betten-System begeistert durch einen einfachen Aufbau mit leicht verständlicher Montageanleitung sowie hochwertigen Verbindungselementen, welche einen vielfachen Ab- und Wiederaufbau ermöglichen.

## Montage facile

Notre système de lits séduit par une installation facile grâce aux instructions de montage bien compréhensibles ainsi que par les éléments de fixation haut de gamme permettant de monter et démonter les lits à de nombreuses reprises.

## Solid in construction

Our beds convince with their high stability. By using different trusses, a total load of 300 to 450 kg, including slatted frames and mattresses, is possible.

## Sustainability at Hasena

Our most important supplier, nature, is sensitive and needs long regeneration times in case of overuse. We respect the ecosystems we use and manufacture our products sustainably and with a high level of social commitment.



## Produktion Massivholz

Production bois massif  
Manufacturing solid wood



## Energiegewinnung

Production énergétique  
Production of energy



# Bettrahmen | Cadre de lit | Bedframe

## Cadro 18



**Breiten** | Largeurs | Widths:  
90, 100, 120, 140, 160, 180, 200 cm

**Längen** | Longueurs | Lengths:  
190, 200, 210, 220 cm

**Einlegetiefe** | Hauteur encastrable | Insertion depth:  
18 cm

## Cadro 23



**Breiten** | Largeurs | Widths:  
120, 140, 160, 180, 200 cm

**Längen** | Longueurs | Lengths:  
200, 210, 220 cm

**Einlegetiefe** | Hauteur encastrable | Insertion depth:  
18\*, 23 cm

## Ausführungen | Exécutions | Executions

### Holz | Bois | Wood



**93 Wildeiche natur, gebürstet, geölt**  
Chêne nouveaux naturel, brossé, huilé  
Wildoak natural, brushed, oiled



**96 Wildeiche pure, gebürstet, geölt**  
Chêne nouveaux pure, brossé, huilé  
Wildoak pure, brushed, oiled



**98 Wildeiche coffee, gebürstet, geölt**  
Chêne nouveaux coffee, brossé, huilé  
Wildoak coffee, brushed, oiled

## \*Aosta 16



**Breiten** | Largeurs | Widths:  
140, 160, 180, 200 cm

**Längen** | Longueurs | Lengths:  
200, 210, 220 cm

**Einlegetiefe** | Hauteur encastrable | Insertion depth:  
16 cm

## \*Pilatus 23



**Breiten** | Largeurs | Widths:  
140, 160, 180, 200 cm

**Längen** | Longueurs | Lengths:  
200, 210, 220 cm

**Einlegetiefe** | Hauteur encastrable | Insertion depth:  
18\*, 23 cm



**\*Aosta 16 und Pilatus 23 nur in Ausführung Wildeiche natur erhältlich.**  
Aosta 16 et Pilatus 23 ne sont disponibles qu'en chêne nouveaux naturel.  
Aosta 16 and Pilatus 23 are only available in Wildoak natural.



# Traversen | Traverses | Bars

**Wir empfehlen grundsätzlich den Einsatz von Crosstraver (Quertraverse) oder Midtraver (Längstraverse).**

Nous recommandons en général l'utilisation de Crosstraver (traverse transversale) ou Midtraver (traverse centrale).

We recommend basically the insertion of Crosstraver (central cross bar) or Midtraver (central bar).

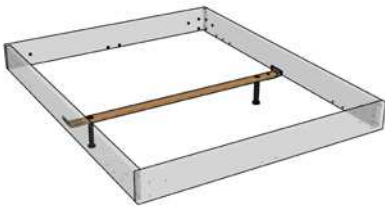

## Crosstraver

Quertraverse | Traverse transversale | Central cross bar

**Für alle Bettbreiten** | Pour toutes les largeurs de lit | For all bed widths

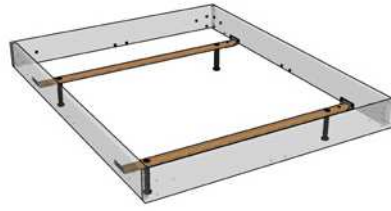

## Crosstraver-Twin

Quertraversen | Traverses transversales | Cross bars

**Für alle Bettbreiten** | Pour toutes les largeurs de lit | For all bed widths

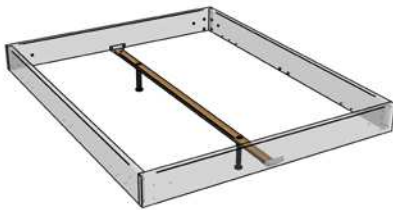

## Midtraver

Längstraverse | Traverse centrale | Central bar

**Für Betten ab Breite 140 cm mit 2 Lattenrosten oder Motorrahmen-einbau** | Pour les lits à partir de 140 cm de largeur avec 2 sommiers ou l'installation d'un cadre motorisé | For beds from 140 cm width with 2 slats or motor frame installation

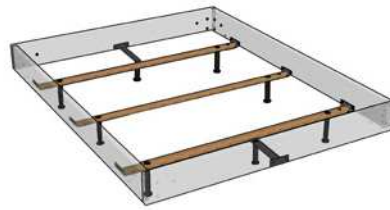

## Crosstraver-XXL

Quertraversen | Traverses transversales | Cross bars

**Für alle Bettbreiten** | Pour toutes les largeurs de lit | For all bed widths

**Übersicht Kompatibilität Traversen siehe Gesamtkatalog Seite 2.12** | Aperçu compatibilité traverses voir catalogue général page 2.12 | Overview compatibility bars see general catalogue page 2.12

## \* Cadro 23/Pilatus 23

**Bei der Einlegetiefe 18 cm sind die Füße/ Sockel um 5 cm versenkt und um diese Höhe weniger sichtbar.**

Avec les équerres en position haute (18 cm) les pieds/sockle sont encastrés de 5 cm sous le cadre et donc moins visibles.

With the insertion depth 18 cm the feet/socket are sunken in by 5 cm and this height less visible.

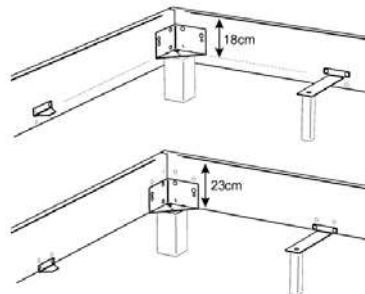

## Option Midtraver-move

**Achtung: nicht bei Füßen in der Höhe 30 cm, Lovie-Box und Practico-Box einsetzbar**

Attention : ne s'applique pas aux pieds à une hauteur de 30 cm, Lovie-Box et Practico-Box

Attention: not applicable for feet at a height of 30 cm, Lovie-Box and Practico-Box

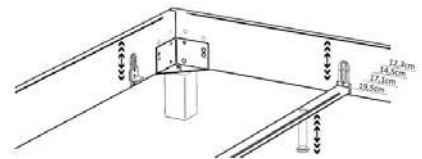

## Wild und ungezähmt

Durch die natürlich vorkommenden Äste und Markstrahlen der Wild-Eiche entstehen faszinierende Farb- und Struktur-Differenzen, die unseren massiven Möbelstücken aus der Oak-Wild-Reihe ihren aussergewöhnlich lebendigen Charakter verleihen. Die Vielzahligen Füße und Kopfteile eröffnen zudem spannende Kombinationsmöglichkeiten mit unterschiedlichen Materialien.

Eichenholz ist ein Naturmaterial, das im Laufe der Jahre reift und seinen Charakter ändert. Bei der Ausführung Wild wird bewusst mit Rissen und Ästen versehenes Holz verwendet, um den speziellen Wild-Look und Charakter zu erreichen.

Farb- und Struktur-differenzen sind bei Echtholz naturbedingte Eigenschaften.

## Sauvage et indompté

Les branches naturelles et les rayons médullaires du chêne sauvage créent des différences de couleur et de structure fascinantes qui confèrent à nos meubles massifs de la gamme Oak-Wild leur caractère extraordinairement vivant. Les nombreux pieds et têtes de lit offrent également des possibilités de combinaison passionnantes avec différents matériaux.

Le bois de chêne est un matériau naturel qui mûrit au fil des ans et change de caractère. La version Wild utilise délibérément du bois avec des fissures et des nœuds pour obtenir l'aspect et le caractère spéciaux Wild.

Les différences de couleur et de structure sont des caractéristiques naturelles du bois véritable.

## Wild and untamed

The naturally occurring branches and medullary rays of wild oak create fascinating differences in colour and structure, which give our massive pieces of furniture from the Oak-Wild range their extraordinarily lively character. The numerous feet and headboards also open up exciting combination possibilities with different materials.

Oak wood is a natural material that matures over the years and changes its character. The Wild version deliberately uses wood with cracks and knots to achieve the special Wild look and character.

Colour and structure differences are natural characteristics of real wood.



# Füsse | Pieds | Feet

Holz | Bois | Wood

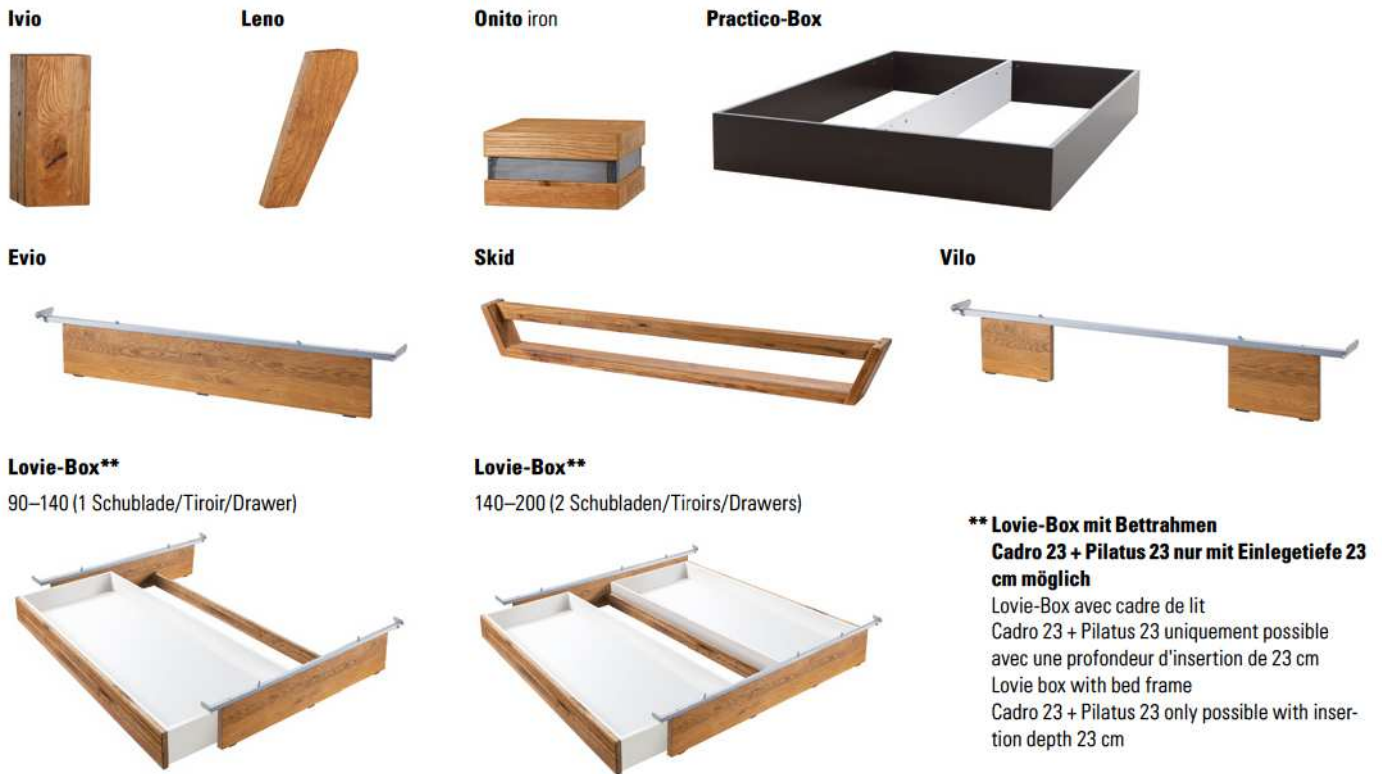

**\*\* Lovie-Box mit Bettrahmen Cadro 23 + Pilatus 23 nur mit Einlegetiefe 23 cm möglich**  
 Lovie-Box avec cadre de lit Cadro 23 + Pilatus 23 uniquement possible avec une profondeur d'insertion de 23 cm  
 Lovie box with bed frame Cadro 23 + Pilatus 23 only possible with insertion depth 23 cm

Holz | Bois | Wood

	Masse cm Dimension cm	Breiten cm Largeurs cm Widths cm	Höhen cm Hauteurs cm Heights cm				Holzfarben Couleurs bois Colours wood					Metallfarben Couleurs métal Colours metal
			10	20	25	30	10	16	93	96	98	45
Evio		90–200										
Ivio	10×10		●	●	●	●						
Leno	6×5,5			●	●							
Lovie-Box** (1 Schublade/Tiroir/Drawer)		90–140			●							
Lovie-Box** (2 Schubladen/Tiroirs/Drawers)		140–200			●							
Onito iron*	18,5×18,5		●								●	
Practico-Box (inkl. Boden   fond inclus   bottom included)		90–200			●							
Skid		140–200			●							
Vilo		90–200		●								

\*nur mit Bettrahmen Cadro 18 und Aosta 16 möglich | uniquement possible avec cadres de lit Cadro 18 et Aosta 16 | only possible with bedframes Cadro 18 and Aosta 16

Bei Cadro 23 und Pilatus 23 (Einlegetiefe 18 cm) sind die Füsse/Sockel um 5 cm versenkt und um diese Höhe weniger sichtbar.

Avec Cadro 23 et Pilatus 23 (hauteur de cadre 18 cm) les pieds/sockle sont encastrés de 5 cm sous le cadre et donc moins visibles.

With Cadro 23 and Pilatus 23 (insertion depth 18 cm) the feet/sockel are sunken in by 5 cm and this height less visible.

Holz | Bois | Wood





# Füsse | Pieds | Feet

Metall | Métal | Metal



Metall | Métal | Metal

	Masse cm Dimension cm	Breiten cm Largeurs cm Widths cm	Höhen cm Hauteurs cm Heights cm				Metallfarben Couleurs métal Colours metal											
			10	20	25	30	00	04	10	16	40	41	42	43	45			
Caro	6x6			•	•		•											
Cielo***		120-200		•					•									
Facil				•														
Fasio	Ø5/9			•							•	•						
Indus	6x2	140-200		•	•													•
Jeno	12x5		•	•	•				•									
Mico	8x8		•	•	•	•			•					•		•		•
Quada	20x6,5			•	•													•
Reca	24x12		•														•	
Road*	Ø 13			•							•							
Slid	8/1	140-200		•	•						•					•		
Soko	Ø 6			•	•				•									
Stomp	Ø 8		•	•	•	•			•									
Tondo	Ø 3,5			•														•

\* Füsse fixiert, Rollen nur optisch | Pieds fixes, roulettes uniquement décoratives | Feet fixed, castors only visual

\*\* Cielo nur mit Rahmen Cadro 18 + 23 möglich | Cielo possible uniquement avec le cadre Cadro 18 + 23 | Cielo only possible with frame Cadro 18 + 23

▲ Curty Vorhang und Vela Baldachin-Tuch siehe Gesamtkatalog Register 2, Seite 2.7 | Curty rideau et Vela tissu de baldaquin voir catalogue général registre 2, page 2.7 | Curty curtain and Vela canopy cloth see general catalogue index 2, page 2.7



00 Chrom = Edelstahl poliert | Acier polité | Stainless steel polished

04 Used = Stahl galvanisiert | Acier galvanisé | Steel galvanised

10 White = Stahl pulverbeschichtet | Acier thermolaqué | Steel powder-coated

16 Anthracit = Stahl pulverbeschichtet | Acier thermolaqué | Steel powder-coated

40 Bronze = Stahl lackiert | Acier laqué | Steel lacquered

41 Copper = Stahl lackiert | Acier laqué | Steel lacquered

42 Alu = Stahl pulverbeschichtet | Acier thermolaqué | Steel powder-coated

43 Inox = Edelstahl geschliffen | Acier poncé | Stainless steel ground

45 Iron = Stahl geflammt, pulverbeschichtet | Acier flammé, thermolaqué | Steel mottled, powder-coated



# Kopfteile | Têtes de lit | Headboards

## Alpa



Dimension: 90/100, 120, 140, 160, 180, 200

## Bordo



Dimension: 140, 160, 180, 200

## Sion



Dimension: 140, 160, 180, 200

## Naturo L



Dimension: 140, 160, 180, 200

## Balco\*



Dimension: 140/160, 180/200

## Lisio

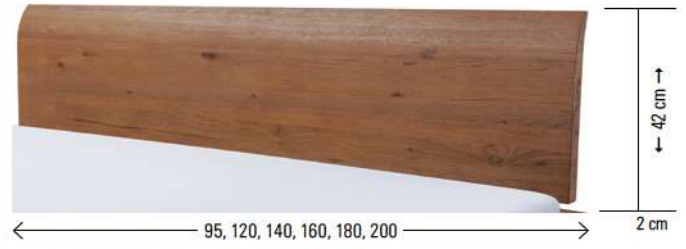

Dimension: 90/100, 120, 140, 160, 180, 200

## Naturo M



Dimension: 140, 160, 180, 200

### Kopfteile | Têtes de lit | Headboards

	Holzfarben Couleurs bois Colours wood		
	93	96	98
Alpa	●	●	●
Balco	●		
Bordo	●	●	
Lisio	●		
Sion	●	●	●
Naturo M	●		
Naturo L	●	●	

\*nur mit Bettrahmen Aosta 16 möglich | uniquement possible avec cadre de lit Aosta 16 | only possible with bed frame Aosta 16

## Adapter | Adaptateur | Adapter

Bei hohen Matratzen kann mit dem Verlängerungsadapter das Kopfteil erhöht werden.

La tête de lit peut être rehaussée avec l'adaptateur lorsque le matelas est plus épais.  
With the extension adapter the headboard can be extended if mattresses are high.

### Head-Plus

Metall | Métal | Metal

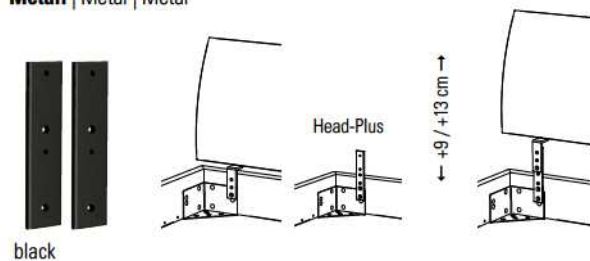

### Balco-Hold L (Balco)

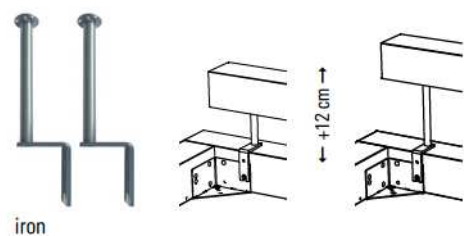



# Kissen zu Kopfteilen | Coussins pour têtes de lit | Cushions for headboards

**Arona + Alpa**



**Lumo + Alpa**



**Nakio + Balco**



**Ravo + Sion**



**Sano + Sion**



**Suny + Alpa**



**Varo + Bordo**



## Befestigung mit 2 Bändern (Klettverschluss)

Fixation avec 2 bandes (Velcro®)

Fixation with 2 ribbons (Velcro®fastener)

**Alle Kissen in Echtleder haben Zier- sowie Teilungsnahte. Ausnahmen: Nakio, Ravo, Suny und Varo, diese Kissen haben lediglich Ziernähte.**

Tous les coussins en cuir véritable ont des coutures décoratives et des coutures de séparation. A l'exception des coussins : Nakio, Ravo, Suny et Varo, ces coussins ont uniquement des coutures décoratives.

All cushions in genuine leather have decorative and dividing seams. Exceptions: Nakio, Ravo, Suny and Varo, these cushions only have decorative seams.

## Kissen | Coussins | Cushions

### Effektive Masse cm

Dimensions effectives cm  
Effective dimensions cm

### zu Kopfteilen pour têtes de lit for headboards

### Breitenmasse cm

Dimensions de largeur cm  
Widths dimensions cm

	Effektive Masse cm Dimensions effectives cm Effective dimensions cm	Alpa	Balco	Naturo M/L	Sion	Bordo	Breitenmasse cm Dimensions de largeur cm Widths dimensions cm
Arona	86, 116, 136, 156, 176×3,5×25	●		●			90/100, 120, 140, 160, 180/200
Lumo	86, 116, 136, 156, 176×6×25	●		●			90/100, 120, 140, 160, 180/200
Nakio (2er Set   set de 2   set of 2)	55×18×14		●				
Ravo	80, 110, 130, 150, 170, 190×3,5×35	●			●	●	90/100, 120, 140, 160, 180, 200
Sano (2er Set   set de 2   set of 2)	55×4×35	●			●		
Suny (2er Set   set de 2   set of 2)	55×6×40	●			●	●	
Varo	55×11×35					●	

# selezione

## 01

### MODELLAUSWAHL

Sélection du modèle | Model selection

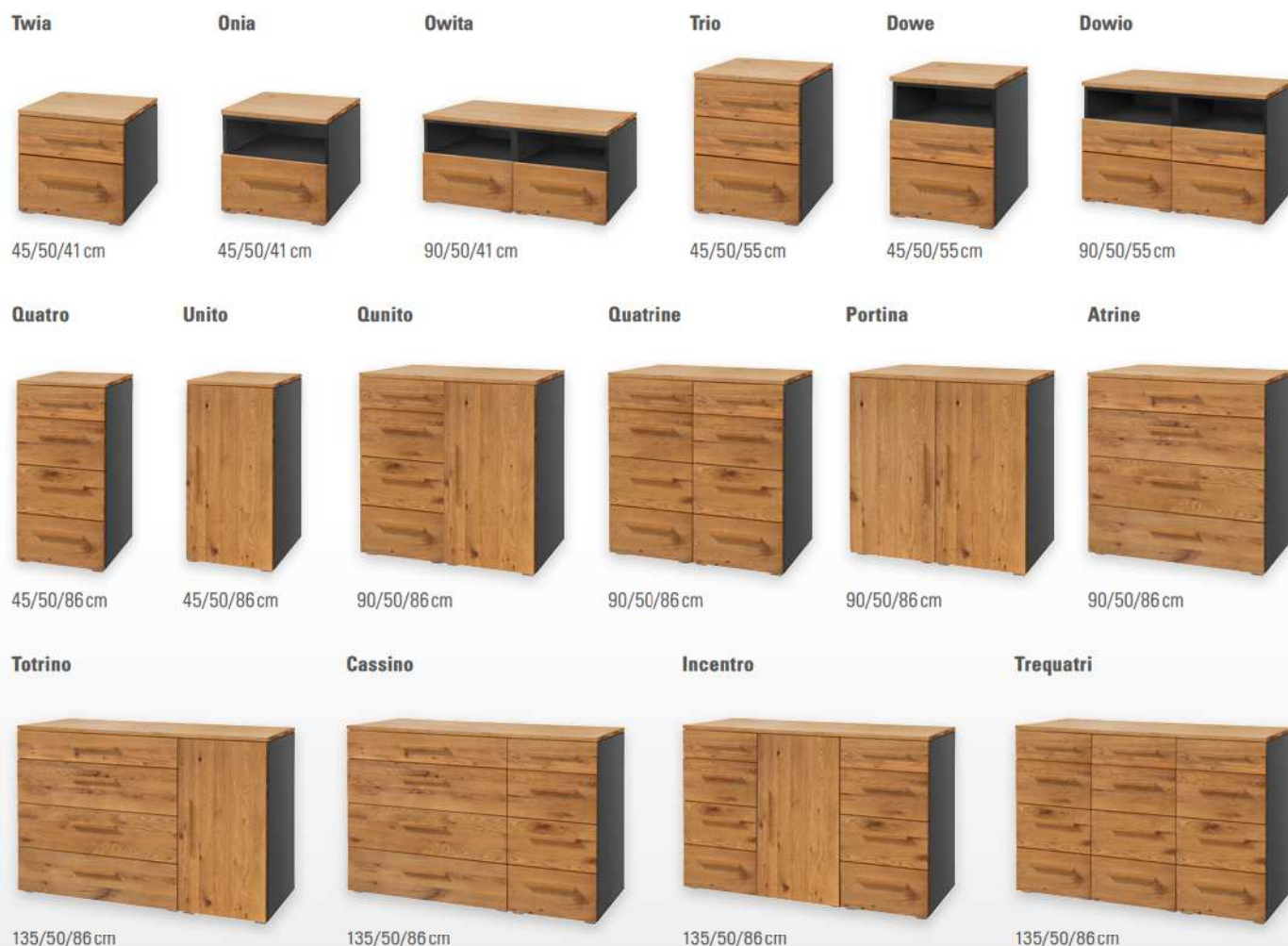
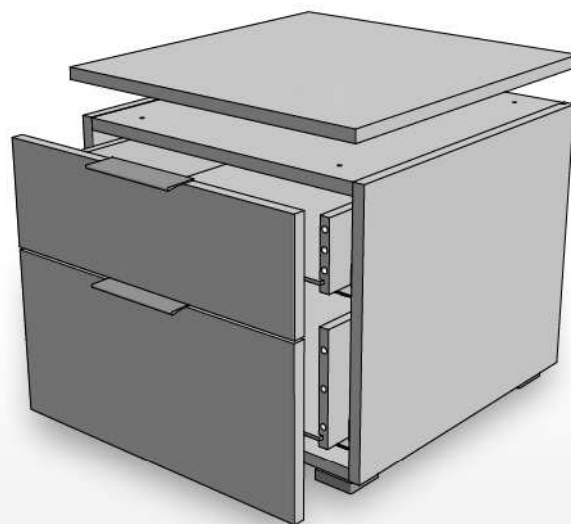

Stellen Sie sich Ihr Wunsch-Beimöbel nach Ihrem Geschmack zusammen: Der Korpus (Abb. 02), in zwei verschiedenen Farbvarianten, lässt sich zu den Front- und Top-Covern (Abb. 03) in acht Holz- und Farbausführungen kombinieren. Die Beimöbel können zerlegt oder teilmontiert bestellt werden. Bei zusammengesetzten Möbeln (z. B. Qunito, Incentro, ...) muss der Deckel noch montiert werden. Bei Kommoden mit Türen ist jeweils ein Einlegeboden vorhanden, Türöffnung nach links oder rechts möglich. Zusätzliche Böden sind erhältlich.

Composez le meuble d'appoint de vos rêves selon vos goûts : Le caisson (ill. 02), disponible en 2 variantes de couleurs, peut être combiné avec les façades et couvercles supérieurs (ill. 03) en 8 finitions de bois et de coloris. Les meubles d'appoint peuvent être commandés en kits ou assemblés. Pour les meubles assemblés (p. ex. Qunito, Incentro, ...) le couvercle doit encore être fixé. Les commodes avec portes sont équipées d'une étagère, ouverture de la porte possible à gauche ou à droite. Si besoin, des étagères supplémentaires sont disponibles.

Put together the side furniture you want according to your own taste: The body (fig. 02), in two different colour versions, can be combined with the front and top covers (fig. 03) in eight wood and colour versions. The furniture can be ordered disassembled or assembled. For assembled furniture (e.g. Qunito, Incentro, ...) the top cover must still be fitted. Chests of drawers with doors have one shelf, door opening possible to the left or right. Additional shelves are available.



**Kombinationsbeispiele und techn. Informationen**  
Exemples et informations  
Examples and informations





# 02

## KORPUS

Caisson | Body



# 03

## TOP/FRONT

Farben | Couleurs | Colours



# 04

## GRIFFE

Poignées | Handles



10 Weiss | Blanc | White



16 Anthracit | Anthracite



## FÜSSE

Pieds | Feet

### STANDARD



### OPTION

Leg 8 cm



alu

Jone 10 cm



anthracit  
used

Cila 10 cm



anthracit



10 Weiss | Blanc | White



16 Anthracit | Anthracite

### STANDARD



Alu

#### Griff zu Folienfronten

Poignée pour façades en mélaminé  
Handle for foil fronts

### STANDARD



#### Holzgriff zu Holzfronten

Poignée en bois pour façades en bois  
Wooden handle for wooden fronts

### OPTION

Rivo



Used



Anthracit

#### Metalgriff zu Holzfronten

Poignée en métal pour façades en bois  
Metal handle for wooden fronts



74 Eiche bright, geölt  
Chêne bright, huilé  
Oak bright, oiled



82 Nussbaum, geölt  
Noyer, huilé  
Walnut, oiled



76 Eiche brandy, geölt  
Chêne brandy, huilé  
Oak brandy, oiled



87 Wildbuche natur, geölt  
Hêtre nouveau naturel, huilé  
Wildbeech natural, oiled



80 Kernbuche natur, geölt  
Hêtre coeur rouge  
naturel, huilé  
Heart beech natural, oiled



99 Wildeiche natur, geölt  
Chêne nouveau naturel, huilé  
Wildoak natural, oiled



				<b>Dimension cm</b>
<b>Calmo</b>	Bank	Banquette	Bench	140/37/38
<b>Caja</b>	Nachttisch	Table de nuit	Bedside table	48/41/16
<b>Smart black</b>	Leselampe (2er Set) schwarz 12V DC, 30 LED warm Dreistufenschaltung	Lampe de lecture (set de 2) noir 12V DC, 30 LED warm Interrupteur à 3 crans	Reading lamp (set of 2) black 12V DC, 30 LED warm Three step circuit	

**Alle Holzteile in Wildeiche natur, gebürstet, geölt** | Toutes les parties en bois en chêne nouveau, brossé, huilé | All wooden parts in wildoak natural, brushed, oiled  
**Leselampen und weitere Beimöbel siehe Gesamtkatalog Register 2** | Lampes de lecture et autres accessoires voir catalogue général registre 2 | Reading lamps and further accessories see general catalogue index 2



# Cadro 18



				Dimension cm
<b>Cadro 18</b>	Rahmen Breiten Längen	Cadre Largeurs Longueurs	Frame Widths Lengths	140, 160, 180, 200 190, 200, 210, 220
<b>Skid</b>	Kufen Breiten Höhe	Patins Largeurs Hauteur	Vats Widths Height	140, 160, 180, 200 25
<b>Alpa</b>	Kopfteil	Tête de lit	Headboard	140, 160, 180, 200
<b>Ravo</b>	Kissen, Alpina anthrazit 391	Coussin, Alpina anthrazit 391	Cushion, Alpina anthrazit 391	140, 160, 180, 200

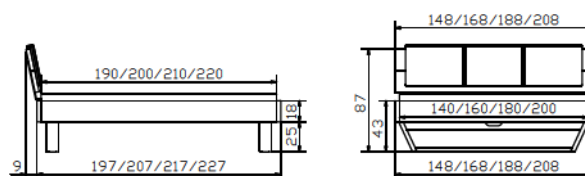



				<b>Dimension cm</b>
<b>Qunito</b>	Kommode	Commode	Chest of drawers	90/50/86
<b>Carpi</b>	Nachttisch höhenverstellbar 34–53 cm	Table de nuit réglable en hauteur 34–53 cm	Bedside table adjustable in height 34–53 cm	52/42/34–53

**Alle Holzteile in Wildeiche natur, gebürstet, geölt** | Toutes les parties en bois en chêne nouveau, brossé, huilé | All wooden parts in wildoak natural, brushed, oiled

**Qunito: Korpus Anthracit** | Caisson anthracite | Body anthracite

**Weitere Beimöbel siehe Gesamtkatalog Register 2** | Autres accessoires voir catalogue général registre 2 | Further accessories see general catalogue index 2





				Dimension cm
<b>Cadro 18</b>	Rahmen Breiten Längen	Cadre Largeurs Longueurs	Frame Widths Lengths	90, 100, 120, 140, 160, 180, 200 190, 200, 210, 220
<b>Leno</b>	Füsse Höhen	Pieds Hauteurs	Feet Heights	20, 25
<b>Boga</b>	Kopfteil, Ranch stone 660 siehe Gesamtkatalog Register 1	Tête de lit, Ranch stone 660 voir catalogue général registre 1	Headboard, Ranch stone 660 see general catalogue index 1	90, 100, 120, 140, 160, 180, 200

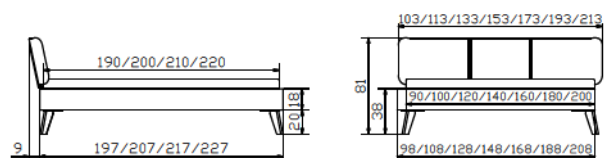



				Dimension cm
<b>Atrine</b>	Kommode	Commode	Chest of drawers	90/50/86
<b>Twia</b>	Nachttisch	Table de nuit	Bedside table	45/50/41

**Alle Holzteile in Wildeiche natur, gebürstet, geölt** | Toutes les parties en bois en chêne nouveau, brossé, huilé | All wooden parts in wildoak natural, brushed, oiled  
**Atrine, Twia: Korpus Anthracit** | Caisson anthracite | Body anthracite

**Weitere Beimöbel siehe Gesamtkatalog Register 2** | Autres accessoires voir catalogue général registre 2 | Further accessories see general catalogue index 2





				<b>Dimension cm</b>
<b>Cadro 18</b>	Rahmen Breiten Längen	Cadre Largeurs Longueurs	Frame Widths Lengths	140, 160, 180, 200 190, 200, 210, 220
<b>Road used</b>	Füße fixiert Rollen nur optisch Höhe	Pieds fixes Roulettes uniquement décoration Hauteur	Feet fixed Castors only visual Height	20
<b>Naturo M</b>	Kopfteil	Tête de lit	Headboard	140, 160, 180, 200

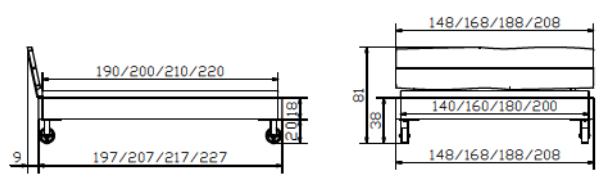



				<b>Dimension cm</b>
<b>Topa</b>	Bank inkl. Kissen Boston tizo 654	Banquette, coussin incl. Boston tizo 654	bench, cushion incl. Boston tizo 654	144/44/38
<b>Caja</b>	Nachttisch	Table de nuit	bedside table	48/41/16

**Alle Holzteile in Wildeiche coffee, gebürstet, geölt** | Toutes les parties en bois en chêne coffee, brossé, huilé | All wooden parts in wildoak coffee, brushed, oiled  
**Weitere Beimöbel siehe Gesamtkatalog Register 2** | Autres accessoires voir catalogue général registre 2 | Further accessories see general catalogue index 2





				Dimension cm
<b>Cadro 18</b>	Rahmen Breiten Längen	Cadre Largeurs Longueurs	Frame Widths Lengths	140, 160, 180, 200 190 (210), 200 (220)
<b>Slid anthracit</b>	Kufen Breiten Höhen	Patins Largeurs Hauteurs	Vats Widths Heights	140, 160, 180, 200 20, 25
<b>Generi</b>	Kopfteil, Boston tizo 654 hat Einfluss auf Bettlänge siehe Gesamtkatalog Register 1 Seite 4	Tête de lit, Boston tizo 654 a un impact sur la longueur du lit voir catalogue général registre 1 page 4	Headboard, Boston tizo 654 affects the length of bed see general catalogue index 1 page 4	140, 160, 180, 200

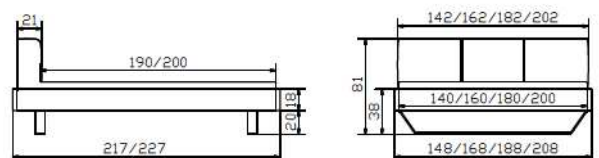



				<b>Dimension cm</b>
<b>Caja</b>	Nachttisch	Table de nuit	Bedside table	48/41/166
<b>Claudio</b> alu	Herrendiener	Valet	Dressboy	45/28/107
<b>Calmo</b>	Bank	Banquette	Bench	140/37/38
<b>Vano</b>	Kissen, Cyclo cream 730	Coussin, Cyclo cream 730	Cushion, Cyclo cream 730	136/34/4

**Alle Holzteile in Wildeiche pure, gebürstet, geölt** | Toutes les parties en bois en chêne nouveau pure, brossé, huilé | All wooden parts in wildoak pure, brushed, oiled  
**Weitere Beimöbel siehe Gesamtkatalog Register 2** | Autres accessoires voir catalogue général registre 2 | Further accessories see general catalogue index 2



# Cadro 23



				Dimension cm
<b>Cadro 23</b>	Rahmen Breiten Längen	Cadre Largeurs Longueurs	Frame Widths Lengths	140, 160, 180, 200 200, 210, 220
<b>Skid</b>	Kufen Breiten Höhe	Patins Largeurs Hauteur	Vats Widths Height	140, 160, 180, 200 25
<b>Naturo L</b>	Kopfteil	Tête de lit	Headboard	140, 160, 180, 200

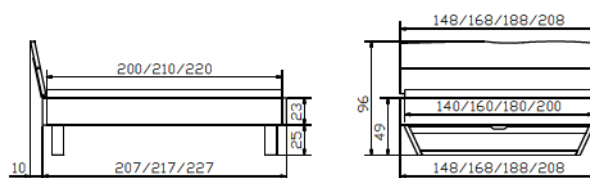





				Dimension cm
<b>Cessina</b>	Kommode	Commode	Chest of drawers	105/46/77
<b>Jone 10 used</b>	Füße	Pieds	Feet	10
<b>Vero</b>	Nachttisch	Table de nuit	Bedside table	50/40/43
<b>Jone 10 used</b>	Füße	Pieds	Feet	10

**Alle Holzteile in Wildeiche natur, gebürstet, geölt** | Toutes les parties en bois en chêne nouveaux, brossé, huilé | All wooden parts in wildoak natural, brushed, oiled  
**Weitere Beimöbel siehe Gesamtkatalog Register 2** | Autres accessoires voir catalogue général registre 2 | Further accessories see general catalogue index 2





				<b>Dimension cm</b>
<b>Cadro 23</b>	Rahmen Breiten Längen	Cadre Largeurs Longueurs	Frame Widths Lengths	140, 160, 180, 200 200, 210, 220
<b>Jeno used</b>	Füße Höhen	Pieds Hauteurs	Feet Heights	10, 20, 25
<b>Cussina</b>	Kopfteil Buffalo grey 721	Tête de lit Buffalo grey 721	Headboard Buffalo grey 721	140, 160, 180, 200 140, 160, 180, 200

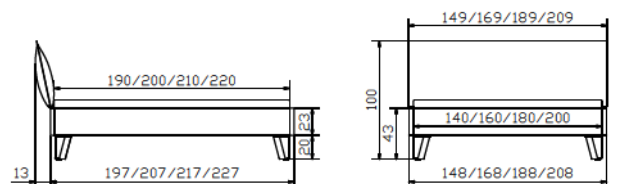



				<b>Dimension cm</b>
<b>Coset</b>	Sekretär	Secrétaire	Bureau	120/60/86
<b>Vecio</b>	Bank/Hocker	Banquette/tabouret	Bench/stool	110/27/45
<b>Onia</b>	Nachttisch	Table de nuit	Bedside table	45/50/41
<b>Curty</b>	Baldachin-Vorhang (3er Set), Baumwolle weiss	Rideau de baldaquin (set de 3), Coton blanc	Curtain of canopy (set of 3), Cotton white	272/185 (3x)



**Naturo L / Arona**





				Dimension cm
<b>Cadro 23</b>	Rahmen Breiten Längen	Cadre Largeurs Longueurs	Frame Widths Lengths	140, 160, 180, 200 200, 210, 220
<b>Cielo anthracit</b>	Baldachin Breiten Höhe	Baldaqin Largeurs Hauteur	Canopy Widths Height	140, 160, 180, 200 20
<b>Naturo L Arona</b>	Kopfteil Kissen, Casual carbon 334	Tête de lit Coussin, Casual carbon 334	Headboard Cushion, Casual carbon 334	140, 160, 180, 200 140, 160, 180/200

**Alle Holzteile in Wildeiche natur, gebürstet, geölt**

Toutes les parties en bois en chêne nouveau naturel, brossé, huilé  
All wooden parts in wildoak natural, brushed, oiled

**Onia: Korpus anthracit** | Caisson anthracite | Body anthracite

**Weitere Beimöbel siehe Gesamtkatalog Register 2**

Autres accessoires voir catalogue général registre 2  
Further accessories see general catalogue index 2

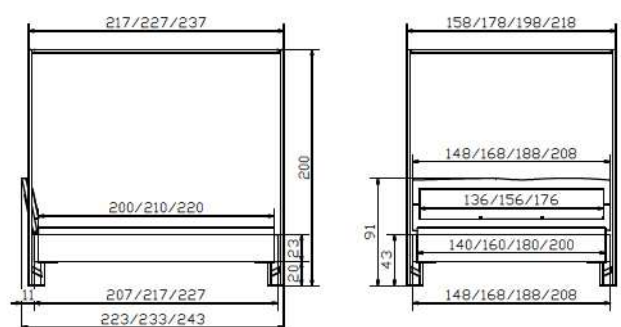



				<b>Dimension cm</b>
<b>Coset</b>	Sekretär	Secrétaire	Bureau	120/60/86
<b>Vecio</b>	Bank	Banquette	Bench	110/27/45
<b>Cessina Seca iron</b>	Kommode Griffe (3er Set)	Commode Poignées (set de 3)	Chest of drawers Handles (set of 3)	105/46/77
<b>Carpi</b>	Nachttisch höhenverstellbar	Table de nuit réglable en hauteur	Bedside table adjustable in height	52/42/34–53

**Alle Holzteile in Wildeiche natur, gebürstet, geölt** | Toutes les parties en bois en chêne nouveau, brossé, huilé | All wooden parts in wildoak natural, brushed, oiled  
**Weitere Beimöbel siehe Gesamtkatalog Register 2** | Autres accessoires voir catalogue général registre 2 | Further accessories see general catalogue index 2





				<b>Dimension cm</b>
<b>Cadro 23</b>	Rahmen Breiten Längen	Cadre Largeurs Longueurs	Frame Widths Lengths	140, 160, 180, 200 200, 210, 220
<b>Indus iron</b>	Kufen Breiten Höhen	Patins Largeurs Hauteurs	Vats Widths Heights	140, 160, 180, 200 20, 25
<b>Sion</b>	Kopfteil	Tête de lit	Headboard	140, 160, 180, 200
<b>Ravo</b>	Kissen, Alpina anthrazit 391	Coussin, Alpina anthrazit 391	Cushion, Alpina anthrazit 391	140, 160, 180, 200

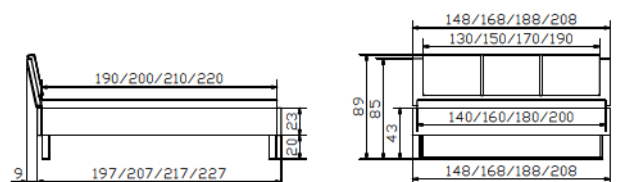



				<b>Dimension cm</b>
<b>Coset</b>	Sekretär	Secrétaire	Bureau	120/60/86
<b>Vero</b>	Nachttisch	Table de nuit	Bedside table	50/40/43
<b>Slid anthracit</b>	Kufen Breiten Höhen	Patins Largeurs Hauteurs	Vats Widths Heights	140, 160, 180, 200 20, 25
<b>Carpi</b>	Nachttisch höhenverstellbar	Table de nuit réglable en hauteur	Bedside table adjustable in height	52/42/34–53





# Aosta 16



				Dimension cm
<b>Aosta 16</b>	Rahmen Breiten Längen	Cadre Largeurs Longueurs	Frame Widths Lengths	140, 160, 180, 200 200, 210, 220
<b>Ivio</b>	Füße Höhen	Pieds Hauteurs	Feet Heights	10, 20, 25, 30
<b>Naturo M</b>	Kopfteil	Tête de lit	Headboard	140, 160, 180, 200

### Alle Holzteile in Wildeiche natur, gebürstet, geölt

Toutes les parties en bois en chêne nouveau naturel, brossé, huilé  
All wooden parts in wildoak natural, brushed, oiled

### Weitere Beimöbel siehe Gesamtkatalog Register 2

Autres accessoires voir catalogue général registre 2  
Further accessories see general catalogue index 2

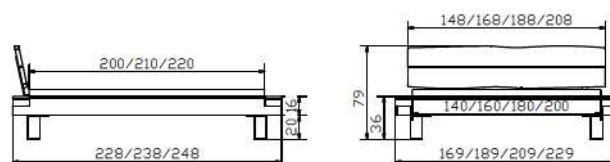



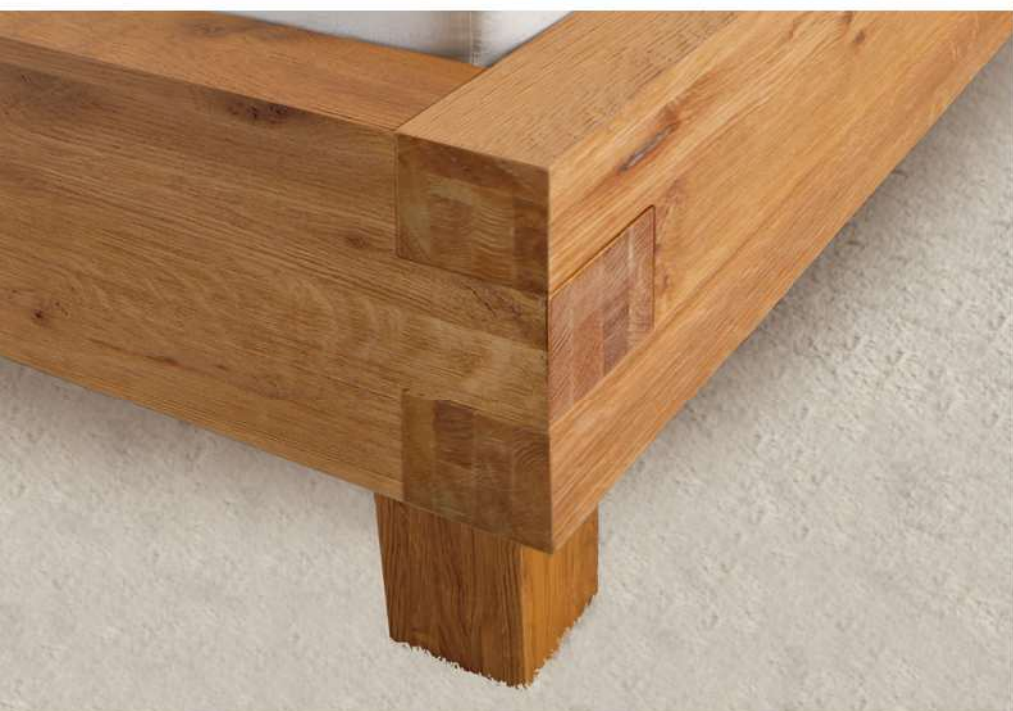

**Alpa**

Kopfteil

Tête de lit

Headboard

**Dimension cm**

140, 160, 180, 200

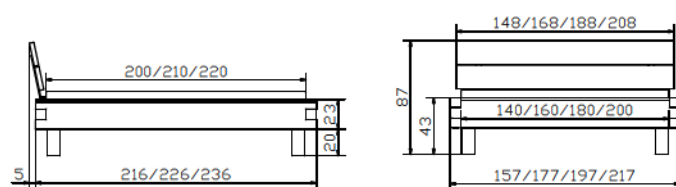



# Pilatus 23



				Dimension cm
<b>Pilatus 23</b>	Rahmen Breiten Längen	Cadre Largeurs Longueurs	Frame Widths Lengths	140, 160, 180, 200 200, 210, 220
<b>Ivio</b>	Füße Höhen	Pieds Hauteurs	Feet Heights	10, 20, 25, 30
<b>Sion</b>	Kopfteil	Tête de lit	Headboard	140, 160, 180, 200
<b>Caja</b>	Nachttisch	Table de nuit	Bedside table	48/41/16

**Alle Holzteile in Wildeiche natur, gebürstet, geölt**

Toutes les parties en bois en chêne nouveau naturel, brossé, huilé  
All wooden parts in wildoak natural, brushed, oiled

**Weitere Beimöbel siehe Gesamtkatalog Register 2**

Autres accessoires voir catalogue général registre 2  
Further accessories see general catalogue index 2

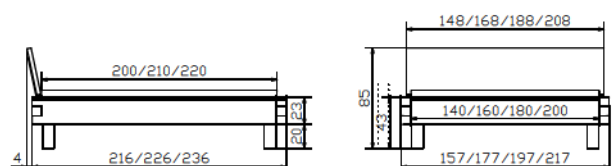





# OAK WILD VINTAGE







				Dimension cm
<b>Claudio</b> anthracit	Herrendiener	Valet	Dressboy	45/28/107
<b>Ludo</b>	Nachttisch/Hocker	Table de nuit/Tabouret	Bedside table/stool	40/40/55
<b>Slid</b> anthracit	Kufen Breiten Höhen	Patins Largeurs Hauteurs	Vats Widths Heights	140, 160, 180, 200 20, 25





# Cadro 23



	<b>Dimension cm</b>			
<b>Cadro 23</b>	Rahmen Breiten Längen	Cadre Largeurs Longueurs	Frame Widths Lengths	140, 160, 180, 200 200, 210, 220
<b>Jeno anthracit</b>	Füße Höhen	Pieds Hauteurs	Feet Heights	10, 20, 25
<b>Obag</b>	Kopfteil Casual carbon 334 siehe Gesamtkatalog Register 1	Tête de lit Casual carbon 334 voir catalogue général registre 1	Headboard Casual carbon 334 see general catalogue index 1	140, 160, 180, 200

**Alle Holzteile in Wildeiche Vintage natur, geölt**  
toutes les parties en bois en chêne nouveau Vintage naturel, huilé  
all wooden parts in wildoak Vintage natural, oiled

**Weitere Beimöbel siehe Gesamtkatalog Register 2**  
Autres accessoires voir catalogue général registre 2  
Further accessories see general catalogue index 2

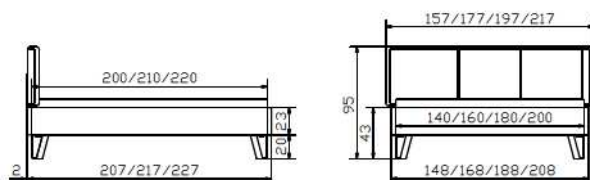





				Dimension cm
<b>Cessina</b>	Kommode	Commode	Chest of drawers	105/46/77
<b>Carpi</b>	Nachttisch höhenverstellbar	Table de nuit réglable en hauteur	Bedside table adjustable in height	52/42/34–53
<b>Snake alu</b>	Leselampe (2er Set) 12V DC, 6 LED 3 Beleuchtungsarten	Lampe de lecture (set de 2) 12V DC, 6 LED 3 différent illuminations	Reading lamp (set of 2) 12V DC, 6 LED 3 different illuminations	

**Alle Holzteile in Wildeiche Vintage natur, geölt** | Toutes les parties en bois en chêne nouveau Vintage naturel, huilé | All wooden parts in wildoak Vintage natural, oiled

**Leselampen und weitere Beimöbel siehe Gesamtkatalog Register 2** | Lampes de lecture et autres accessoires voir catalogue général registre 2 | Reading lamps and further accessories see general catalogue index 2



# Cadro 18



				Dimension cm
<b>Cadro 18</b>	Rahmen Breiten Längen	Cadre Largeurs Longueurs	Frame Widths Lengths	140, 160, 180, 200 190, 200, 210, 220
<b>Jeno anthracit</b>	Füße Höhen	Pieds Hauteurs	Feet Heights	10, 20, 25
<b>Naturo L</b>	Kopfteil	Tête de lit	Headboard	140, 160, 180, 200

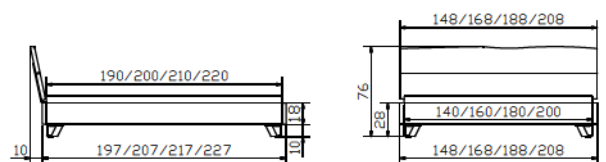







# OAK WILD ASPINO BORMIO CORTINA



# Betten | Lits | Beds

## Bormio 18



**Breiten** | Largeurs | Widths:  
140, 160, 180, 200 cm

**Längen** | Longueurs | Lengths:  
200, 210, 220 cm

**Fusshöhen** | Hauteur des pieds | Foot heights:  
10, 20, 25 cm

**Einlegetiefe** | Hauteur encastrable | Insertion depth:  
18 cm

## Cortina 18



**Breiten** | Largeurs | Widths:  
140, 160, 180, 200 cm

**Längen** | Longueurs | Lengths:  
200, 210, 220 cm

**Fusshöhen** | Hauteur des pieds | Foot heights:  
10, 20, 25 cm

**Einlegetiefe** | Hauteur encastrable | Insertion depth:  
18 cm

## Aspino 18



**Breiten** | Largeurs | Widths:  
140, 160, 180, 200 cm

**Längen** | Longueurs | Lengths:  
200, 210, 220 cm

**Fusshöhe** | Hauteur des pied | Foot height:  
20 cm

**Einlegetiefe** | Hauteur encastrable | Insertion depth:  
18 cm

## Ausführungen | Exécutions | Executions

### Holz | Bois | Wood



**93**  
**Wildeiche natur,**  
**gebürstet, geölt**

Chêne nouveau naturel,  
brossé, huilé  
Wildoak natural, brushed,  
oiled



# Traversen | Traverses | Bars

**Wir empfehlen grundsätzlich den Einsatz von Crosstraver (Quertraverse) oder Midtraver (Längstraverse).**

Nous recommandons en général l'utilisation de Crosstraver (traverse transversale) ou Midtraver (traverse centrale).

We recommend basically the insertion of Crosstraver (central cross bar) or Midtraver (central bar).

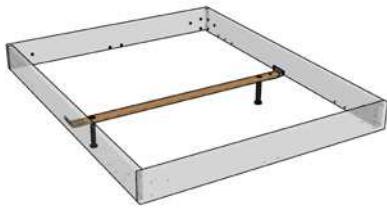

## Crosstraver

Quertraverse | Traverse transversale | Central cross bar

**Für alle Bettbreiten** | Pour toutes les largeurs de lit | For all bed widths

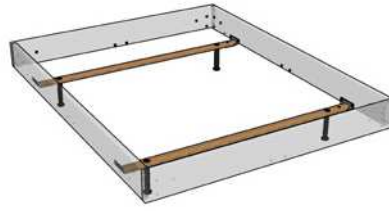

## Crosstraver-Twin

Quertraversen | Traverses transversales | Cross bars

**Für alle Bettbreiten** | Pour toutes les largeurs de lit | For all bed widths

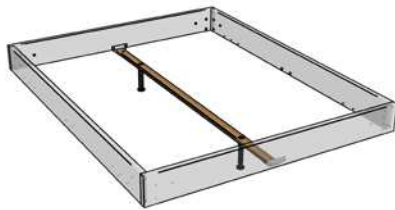

## Midtraver

Längstraverse | Traverse centrale | Central bar

**Für Betten ab Breite 140 cm mit 2 Lattenrosten oder Motorrahmen-einbau** | Pour les lits à partir de 140 cm de largeur avec 2 sommiers ou l'installation d'un cadre motorisé | For beds from 140 cm width with 2 slats or motor frame installation

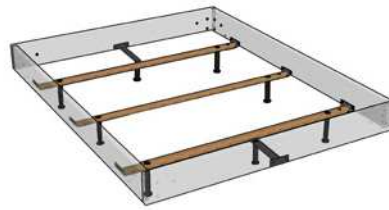

## Crosstraver-XXL

Quertraversen | Traverses transversales | Cross bars

**Für alle Bettbreiten** | Pour toutes les largeurs de lit | For all bed widths

**Übersicht Kompatibilität Traversen siehe Gesamtkatalog Seite 2.12** | Aperçu compatibilité traverses voir catalogue général page 2.12 | Overview compatibility bars see general catalogue page 2.12

# Bettkasten | Coffres à literie | Bedding boxes

## Roll-Box 20/25



Bettkasten in weiss oder anthrazit (Boden weiss)

### Voraussetzung

Bettfusshöhe von mindestens 20 cm erforderlich

### Optionen

Deckel Covero in weiss, Stoffabdeckung Saceto in Polyester grau.

## Roll-Box 20/25 + Covero



Tiroir de lit en blanc ou anthracite (fond blanc)

### Condition préalable

Une hauteur de pieds de lit d'au moins 20 cm est nécessaire

### Options

Couvercle Covero en blanc, tissu de protection Saceto en polyester gris.

## Roll-Box 20/25 + Saceto



Bed drawer in white or anthracite (bottom white)

### Condition

Feet of bed need a minimum height of 20 cm

### Options

Cover Covero in white, tissue of protection Saceto in polyester grey.



### Roll-Box 20



### Roll-Box 25



### Stauraum | Espace de rangement | Storage space

Roll-Box 20	=	134 × 61 × 13 cm
Roll-Box 25	=	134 × 61 × 16 cm



<b>Menza</b>	Nachttisch	Table de nuit	Bedside table	<b>Dimension cm</b> 48/38/40
--------------	------------	---------------	---------------	---------------------------------

**Alle Holzteile in Wildeiche natur, gebürstet, geölt** | Toutes les parties en bois en chêne nouveau, brossé, huilé | All wooden parts in wildoak natural, brushed, oiled  
**Weitere Beimöbel siehe Gesamtkatalog Register 2** | Autres accessoires voir catalogue général registre 2 | Further accessories see general catalogue index 2



# Aspino 18



	<b>Dimension cm</b>			
<b>Aspino 18</b>	Rahmen Breiten Längen Höhe	Cadre Largeurs Longueurs Hauteur	Frame Widths Lengths Height	140, 160, 180, 200 200, 210, 220 20
<b>Alpa + Lumo</b>	Kopfteil Boucle ivory 770	Tête de lit Boucle ivory 770	Headboard Boucle ivory 770	140, 160, 180, 200

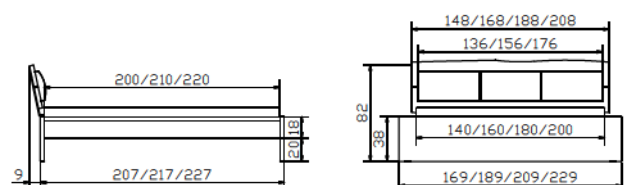



				<b>Dimension cm</b>
<b>Cessina</b>	Kommode	Commode	Chest of drawers	105/48/77
<b>Roll-Box 20</b>	Bettkasten Höhen	Tiroir de lit Hauteurs	Bed drawer Heights	137/67 20, 25
<b>Turina</b>	Nachttisch	Table de nuit	Bedside table	50/42/57





# Bormio 18



				Dimension cm
<b>Bormio 18</b>	Rahmen Breiten Längen	Cadre Largeurs Longueurs	Frame Widths Lengths	140, 160, 180, 200 200, 210, 220
<b>Sion Sano</b>	Kopfteil Kissen (2er Set) Vintage fango 520	Tête de lit Coussins (Set de 2) Vintage fango 520	Headboard Cushions (Set of 2) Vintage fango 520	140, 160, 180, 200 55/4/35

### Alle Holzteile in Wildeiche natur, gebürstet, geölt

Toutes les parties en bois en chêne nouveau naturel, brossé, huilé  
All wooden parts in wildoak natural, brushed, oiled

### Weitere Beimöbel siehe Gesamtkatalog Register 2

Autres accessoires voir catalogue général registre 2  
Further accessories see general catalogue index 2

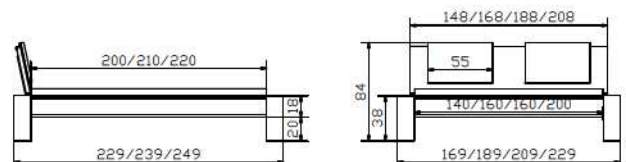



<b>Cuba</b>	Nachttisch	Table de nuit	Bedside table	<b>Dimension cm</b> 50/40/43
-------------	------------	---------------	---------------	---------------------------------

**Alle Holzteile in Wildeiche natur, gebürstet, geölt** | Toutes les parties en bois en chêne nouveau, brossé, huilé | All wooden parts in wildoak natural, brushed, oiled  
**Weitere Beimöbel siehe Gesamtkatalog Register 2** | Autres accessoires voir catalogue général registre 2 | Further accessories see general catalogue index 2



# Cortina 18



				Dimension cm
<b>Cortina 18</b>	Rahmen Breiten Längen	Cadre Largeurs Longueurs	Frame Widths Lengths	140, 160, 180, 200 200, 210, 220
<b>Sion</b>	Kopfteil	Tête de lit	Headboard	140, 160, 180, 200

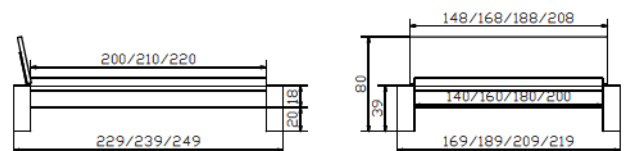





**MOVIE-/TOP LINE**



**FACTORY LINE**



**WOOD LINE**



**LOUNGE**



**FINE LINE**



**NATURO LINE**



**OAK LINE**



**OAK WILD**



**DREAM LINE**



**EDITION  
BOXSPRING**



**FUNCTION/COMFORT  
KIDS & GUESTS**



**LATTENROSTE &  
MATRATZEN**



**Gesamtkatalog**  
Catalogue général  
General catalogue