



swiss bed concept



# TRENTO

MASSIVHOLZ | BOIS MASSIF | SOLID WOOD

Achten Sie auf FSC®-zertifizierte Produkte | Soyez attentifs aux produits certifiés FSC® | Look for FSC®-certified products



# Hasena – mein Bett

Hasena – mon lit | Hasena – my bed

## Beständige Passion

Une passion constante  
Enduring Passion



### Mehr als ein Lebenswerk

Als Familienunternehmen gegründet, überzeugen wir seit über 70 Jahren mit hoher Qualität und Vielseitigkeit im Bereich Schlafzimmermöbel.

### Plus que l'œuvre d'une vie

Fondée en tant qu'entreprise familiale, nous convainquons depuis plus de 70 ans par notre qualité élevée et notre polyvalence dans le domaine des meubles de chambre à coucher.

### More than a life's work

Founded as a family business, we have been impressing with high quality and versatility in the field of bedroom furniture for over 70 years.

## swiss bed concept



swiss bed concept

### Ein cleveres Baukastensystem

Sie wählen Ihren favorisierten Bettrahmen aus und kombinieren dazu Füße und Kopfteil Ihrer Wahl. Dabei können Sie quer durch die Kollektionen auf unterschiedliche Materialien und Farben zugreifen.

### Un système modulaire astucieux

Vous choisissez votre cadre de lit préféré et le combinez avec les pieds et les têtes de lit de votre choix. Vous pouvez choisir parmi une variété de matériaux et de couleurs dans toutes les collections.

### A clever modular system

You choose your favourite bed frame and combine it with the feet and headboards of your choice. You can choose from a variety of materials and colours throughout the collections.

## 5 Jahre Garantie

Service de livraison rapide  
5 years warranty



### Unser Versprechen

Vom Baum zum Bett – mittels handwerklicher Perfektion und hochwertigen Materialien. Sie erhalten 5 Jahre Garantie auf die Material- und Oberflächenbeschaffenheit, sowie die fachgerechte Verarbeitung aller Modelle ab Kaufdatum. Weitere Informationen finden Sie auf unserer Website.

### Notre promesse

De l'arbre au lit – grâce à un artisanat parfait et des matériaux de haute qualité. Vous bénéficiez d'une garantie de 5 ans sur la qualité des matériaux et des surfaces, ainsi que sur la fabrication professionnelle de tous les modèles à compter de la date d'achat. Vous trouverez plus d'informations sur notre site Internet.

### Our promise

From tree to bed – by means of perfect craftsmanship and high-quality materials. You receive a 5-year guarantee on the material and surface quality, as well as the professional workmanship of all models from the date of purchase. Further information can be found on our website.

## Schnellieferservice

Service de livraison rapide  
Quick delivery service



### Komfort ohne Wartezeit

Mit unserem Schnellieferservice «PRONTO» können wir eine grosse Auswahl an Betten mit Beimöbeln und alle Modelle aus Edition pronto, Dream pronto und Boxspring pronto ab Lager liefern.

### Le confort sans attente

Notre service de livraison rapide « PRONTO » permet de livrer un large choix de lits, de meubles d'appoint et tous les modèles de l'Édition Pronto, Dream pronto et Boxspring Pronto à partir du stock.

### Comfort without waiting

With our quick delivery service «PRONTO» we can offer a large selection of beds with ancillary furniture and all models from models from Edition pronto, Dream pronto and Boxspring pronto from stock.





## Vielseitig kombinierbar

Unser ausgeklügeltes Baukastensystem «swiss bed concept» bietet eine riesige Auswahl an Füßen, Kopfteilen und Beimöbeln. Darüber hinaus umfasst es verschiedene Stoff-, Kunstleder- und Lederbezüge sowie diverse Holz- und Metallausführungen. Abgestimmte Lattenroste und Matratzen komplettieren unsere Betten zur Wohlfühloase.

## Combinable à versatile

Notre système modulaire sophistiqué «swiss bed concept» propose un choix énorme de pieds, têtes de lits et accessoires. Par ailleurs le comporte différents tissus, cuirs synthétiques et véritables, ainsi que diverses variantes de bois et métal. Des sommiers à lattes et des matelas adaptés complètent nos lits pour un espace bien-être.

## Versatile combinable

Our ingenious modular system «swiss bed concept» offers a huge selection of feet, headboards and accessories. In addition, it includes different fabrics, synthetic leather and real leather covers and different wood and metal versions. Matching slatted frames and mattresses complete our beds to an oasis of well-being.

## Nachhaltigkeit bei Hasena

Unser wichtigster Lieferant, die Natur, ist sensibel und benötigt lange Regenerationszeiten bei Überbeanspruchung. Wir respektieren die von uns genutzten Ökosysteme und stellen unsere Produkte nachhaltig und mit hohem sozialen Engagement her.



## Soziale Verantwortung

Responsabilité sociale  
Social responsibility



## Holzoberflächen

Surfaces en bois  
Wood surfaces



## Stabil im Aufbau

Unsere Betten überzeugen durch eine hohe Stabilität. Mittels Einsatz verschiedener Traversen ist eine gesamthafte Belastung von 300 bis 450 kg, inklusive Lattenroste und Matratzen, möglich.

## Construction robuste

Nos lits sont convainçants par leur grande stabilité. En utilisant différentes fermes, une charge totale de 300 à 450 kg, y compris les sommiers à lattes et les matelas, est possible.

## Solid in construction

Our beds convince with their high stability. By using different trusses, a total load of 300 to 450 kg, including slatted frames and mattresses, is possible.

## Durabilité chez Hasena

Notre fournisseur le plus important, la nature, est sensible et nécessite un long temps de régénération en cas de surutilisation. Nous respectons les écosystèmes que nous utilisons et fabriquons nos produits de manière durable et avec un haut niveau d'engagement social.



## Holzbeschaffung

Approvisionnement en bois  
Wood procurement



## Recycelte Stoffe

Tissus recyclés  
Recycled fabrics



## Einfach in der Montage

Unser Betten-System begeistert durch einen einfachen Aufbau mit leicht verständlicher Montageanleitung sowie hochwertigen Verbindungselementen, welche einen vielfachen Ab- und Wiederaufbau ermöglichen.

## Montage facile

Notre système de lits séduit par une installation facile grâce aux instructions de montage bien compréhensibles ainsi que par les éléments de fixation haut de gamme permettant de monter et démonter les lits à de nombreuses reprises.

## Solid in construction

Our beds convince with their high stability. By using different trusses, a total load of 300 to 450 kg, including slatted frames and mattresses, is possible.

## Sustainability at Hasena

Our most important supplier, nature, is sensitive and needs long regeneration times in case of overuse. We respect the ecosystems we use and manufacture our products sustainably and with a high level of social commitment.



## Produktion Massivholz

Production bois massif  
Manufacturing solid wood



## Energiegewinnung

Production énergétique  
Production of energy



# Trento als System

Trento en tant que système | Trento as a system



**Bettrahmen** | Cadre de lit | Bedframe



**Füsse** | Pieds | Feet



**Kopfteil** | Tête de lit | Headboards



**Kissen** | Coussins | Cushions



Siehe Seiten 8 – 27  
Voir pages 8 – 27  
See pages 8 – 27

## **Pietro Komplettbett** | Pietro lit complet | Pietro complete bed

Siehe Seiten 28 – 29

Voir pages 28 – 29

See pages 28 – 29



## **Simone Komplettbett** | Simone lit complet | Simone complete bed

Siehe Seiten 30 – 31

Voir pages 30 – 31

See pages 30 – 31



# selezione

## 01

### MODELLAUSWAHL

Sélection du modèle | Model selection

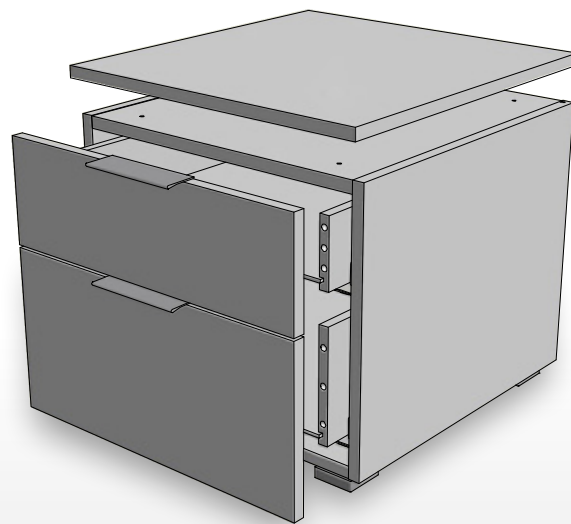

Twia



45/50/41 cm

Onia



45/50/41 cm

Owita



90/50/41 cm

Trio



45/50/55 cm

Dowe



45/50/55 cm

Dowio



90/50/55 cm

Quatro



45/50/86 cm

Unito



45/50/86 cm

Qunito



90/50/86 cm

Quatrine



90/50/86 cm

Portina



90/50/86 cm

Atrine



90/50/86 cm

Totrino



135/50/86 cm

Cassino



135/50/86 cm

Incentro



135/50/86 cm

Trequatri



135/50/86 cm

Stellen Sie sich Ihr Wunsch-Beimöbel nach Ihrem Geschmack zusammen: Der Korpus (Abb. 02), in zwei verschiedenen Farbvarianten, lässt sich zu den Front- und Top-Covern (Abb. 03) in fünf Holz- und Farbausführungen kombinieren. Die Beimöbel können zerlegt oder teilmontiert bestellt werden. Bei zusammengesetzten Möbeln (z. B. Qunito, Incentro, ...) muss der Deckel noch montiert werden. Bei Kommoden mit Türen ist jeweils ein Einlegeboden vorhanden, Türöffnung nach links oder rechts möglich. Zusätzliche Böden sind erhältlich.

Composez le meuble d'appoint de vos rêves selon vos goûts : Le caisson (ill. 02), disponible en 2 variantes de couleurs, peut être combiné avec les façades et couvercles supérieurs (ill. 03) en 5 finitions de bois et de coloris. Les meubles d'appoint peuvent être commandés en kits ou assemblés. Pour les meubles assemblés (p. ex. Qunito, Incentro, ...) le couvercle doit encore être fixé. Les commodes avec portes sont équipées d'une étagère, ouverture de la porte possible à gauche ou à droite. Si besoin, des étagères supplémentaires sont disponibles.

Put together the side furniture you want according to your own taste: The body (fig. 02), in two different colour versions, can be combined with the front and top covers (fig. 03) in five wood and colour versions. The furniture can be ordered disassembled or assembled. For assembled furniture (e.g. Qunito, Incentro, ...) the top cover must still be fitted. Chests of drawers with doors have one shelf, door opening possible to the left or right. Additional shelves are available.



**Kombinationsbeispiele und techn. Informationen**  
Exemples et informations  
Exemples and informations

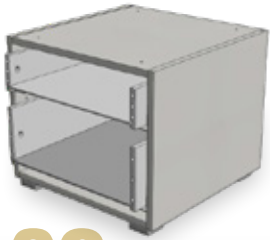

# 02

## KORPUS

Caisson | Body



# 03

## TOP/FRONT

Farben | Couleurs | Colours

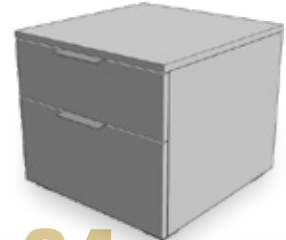

# 04

## GRIFFE

Poignées | Handles



10 Weiss | Blanc | White



16 Anthracit | Anthracite



## FÜSSE

Pieds | Feet

### STANDARD



### OPTION

Leg 8 cm



alu

Jone 10 cm



anthracit  
used

Cila 10 cm



anthracit



10 Weiss | Blanc | White



16 Anthracit | Anthracite

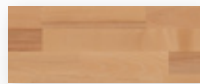

80 Kernbuche natur, geölt

Hêtre coeur rouge  
naturel, huilé  
Heart beech natural, oiled

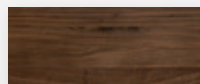

82 Nussbaum, geölt

Noyer, huilé  
Walnut, oiled

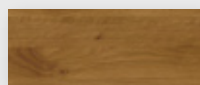

99 Wildeiche natur, geölt

Chêne nouveau naturel, huilé  
Wildoak natural, oiled

### STANDARD



Alu

Griff zu Folienfronten

Poignée pour façades en mélaminé  
Handle for foil fronts

### STANDARD



Holzgriff zu Holzfronten

Poignée en bois pour façades en bois  
Wooden handle for wooden fronts

### OPTION

Rivo



Used



Anthracit

Metallgriff zu Holzfronten

Poignée en métal pour façades en bois  
Metal handle for wooden fronts



The mark of  
responsible forestry  
FSC® C123546

Look for FSC® certified products

# Bettrahmen | Cadre de lit | Bedframe

## Trento



**Breiten** | Largeurs | Widths:  
90, 100, 120, 140, 160, 180, 200 cm

**Länge** | Longueur | Length:  
200 cm

### Midtraver

Längstraverse  
Traverse centrale  
Central bar

200 cm  
210 cm\*

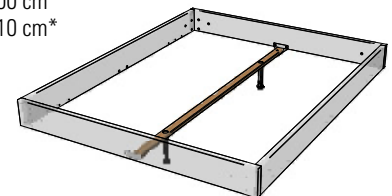

\* für Bettgestell Pietro und Simone | pour le lit Pietro et Simone | for bed frame Pietro and Simone

## Empfehlung | Recommandation | Recommendation

Wir empfehlen für Betten ab 140 cm mit 2 Lattenrosten oder für den Motorrahmeneinbau eine **Midtraver** (Längstraverse).

Nous recommandons une **Midtraver** (traverse centrale) pour un cadre de lit à partir de 140 cm avec 2 sommiers ou pour l'encastrement d'un sommier à moteur.

For beds wider than 140 cm with 2 slats or motorframes we recommend a **Midtraver** (central bar).

## Ausführungen für Bettrahmen | Exécutions pour cadres de lit | Executions for frames



**10**  
**Buche weiss deckend, lackiert**  
Hêtre teinté blanc couvrant laqué  
Beech white covered, lacquered



**71**  
**Eiche bianco, geölt**  
Chêne bianco, huilé  
Oak bianco, oiled



**80**  
**Kernbuche natur, geölt**  
Hêtre coeur rouge naturel, huilé  
Heart beech natural, oiled

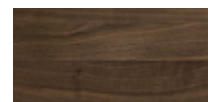

**82**  
**Nussbaum, geölt**  
Noyer, huilé  
Walnut, oiled



**99**  
**Wildeiche natur, geölt**  
Chêne nouveaux naturel, huilé  
Wildoak natural, oiled

## Deklaration der Holzherkunft | Déclaration de l'origine du bois | Declaration of origin of wood

**Buche** | Hêtre | Beech

**Eiche** | Chêne | Oak

**Nussbaum** | Noyer | Walnut

**Europa** | Europe

**Europa, USA** | Europe, USA

**Europa** | Europe



# Füsse | Pieds | Feet

Nelo



Tunca



Roca



Tondo



Glyd



## Holz | Bois | Wood

	Masse cm Dim. cm	Breiten cm Largeurs cm Widths cm	Höhen cm Hauteurs cm Heights cm	Holzfarben Couleurs bois Colours wood
			20 25	10 71 80 82 99
Nelo	6 x 5,5		● ●	● ● ● ● ●
Tunca	8 x 8		● ●	● ● ● ● ●

## Metall | Métal | Metal

	Masse cm Dim. cm	Breiten cm Largeurs cm Widths cm	Höhen cm Hauteurs cm Heights cm	Metallfarben Couleurs métal Colours metal
			20 25	16 42 45
Glyd		140–180	● ●	● ● ● ● ●
Roca	6 x 6		● ●	● ● ● ● ●
Tondo			● ●	● ● ● ● ●

## Ausführungen für Füsse | Exécutions pour pieds | Executions for feet

### Holz | Bois | Wood



**10**  
**Buche weiss deckend, lackiert**  
Hêtre teinté blanc couvrant laqué  
Beech white covered, lacquered



**71**  
**Eiche bianco, geölt**  
Chêne bianco, huilé  
Oak bianco, oiled



**80**  
**Kernbuche natur, geölt**  
Hêtre coeur rouge naturel, huilé  
Heart beech natural, oiled



**82**  
**Nussbaum, geölt**  
Noyer, huilé  
Walnut, oiled



**99**  
**Wildeiche natur, geölt**  
Chêne nouveaux naturel, huilé  
Wildoak natural, oiled

### Metall | Métal | Metal



**16**  
**anthracit**



**42**  
**alu**



**45**  
**iron**



The mark of responsible forestry  
FSC® C123546

Look for FSC® certified products

# Kopfteile | Têtes de lit | Headboards

## Holz | Bois | Wood

### Ello



Dimension 90/100, 120, 140, 160, 180/200 cm

### Pella



Dimension 90/100, 120, 140, 160, 180/200 cm

### \*Turano



Dimension 140, 160, 180 cm

**\*ausschliesslich in Wildeiche natur, geölt und Nussbaum, geölt**  
exclusivement en chêne nouveau naturel, huilé et noyer, huilé  
exclusively in wildoak natural, oiled and walnut, oiled

## gepolstert | rembourrées | upholstered

### Lecco



Dimension 90/100, 120, 140, 160, 180/200 cm

### Lola für / pour / for Ello + Pella

Kissen (2er Set) | Coussins (set de 2) | Cushions (set of 2)



Dimension 55/35/3,5 cm

## Adapter | Adaptateur | Adapter

**Bei hohen Matratzen kann mit dem Verlängerungsadapter das Kopfteil erhöht werden.**

La tête de lit peut être rehaussée avec l'adaptateur quand le matelas est plus épais.  
With the extension adapter the headboard can be extended if mattresses are high.

### Head-Plus (2er Set | set de 2 | set of 2)

**Metall | Métal | Metal**

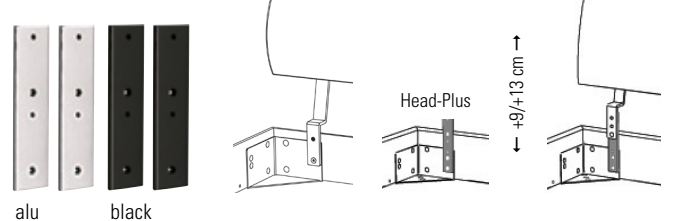

## Ausführungen für Kopfteile | Executions pour têtes de lit | Executions for headboards



**10 Buche weiss deckend, lackiert**  
Hêtre teinté blanc couvrant laqué  
Beech white covered, lacquered



**71 Eiche bianco, geölt**  
Chêne bianco, huilé  
Oak bianco, oiled



**80 Kernbuche natur, geölt**  
Hêtre coeur rouge naturel, huilé  
Heart beech natural, oiled

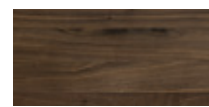

**82 Nussbaum, geölt**  
Noyer, huilé  
Walnut, oiled

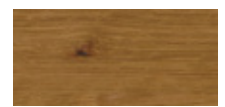

**99 Wildeiche natur, geölt**  
Chêne nouveau naturel, huilé  
Wildoak natural, oiled

## Stoffauswahl für Lecco und Lola | Choix de tissus pour Lecco et Lola | Selection of tissues for Lecco and Lola



323 white

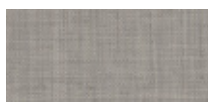

335 Pepe grey

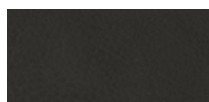

336 smoke

# Nachttische | Tables de nuit | Bedside tables



Akai

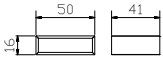

Salva

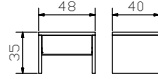

Jaca

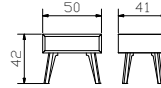

Jose

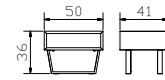

# Bettkasten | Coffre à literie | Bedding box

Roll-Box 20/25



**Bettkasten in weiss oder anthrazit**

**Voraussetzung**

Bettfusshöhe von mindestens 20 cm erforderlich

**Optionen**

Deckel Covero in weiss, Stoffabdeckung Saceto in Polyester grau.

Roll-Box 20/25 + Covero



**Tiroir de lit en blanc ou anthracite**

**Condition préalable**

Une hauteur de pieds de lit d'au moins 20 cm.

**Options**

Couvercle Covero en blanc, tissu de protection Saceto en polyester gris.

Roll-Box 20/25 + Saceto



**Bed drawer in white or anthracite**

**Condition**

Feet of bed need a minimum height of 20 cm.

**Options**

Covero in white, tissue of protection Saceto in polyester grey.

## Ausführungen für Bettkasten-Front | Exécutions pour façades coffres à literie | Executions for fronts of bedding boxes

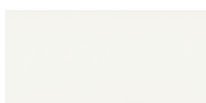

**10**  
**Buche weiss deckend, lackiert**  
Hêtre teinté blanc couvrant laqué  
Beech white covered, lacquered



**16**  
**Buche anthracit deckend, lackiert**  
Hêtre teinté anthracite couvrant laqué  
Beech anthracite covered, lacquered



**71**  
**Eiche bianco, geölt**  
Chêne bianco, huilé  
Oak bianco, oiled



**80**  
**Kernbuche natur, geölt**  
Hêtre coeur rouge naturel, huilé  
Heart beech natural, oiled

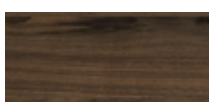

**82**  
**Nussbaum, geölt**  
Noyer, huilé  
Walnut, oiled



**93**  
**Wildeiche natur, gebürstet, geölt**  
Chêne nouveau naturel, brossé, huilé  
Wildoak natural, brushed, oiled

## Herrendiener | Valet | Dressboy

Claudio



**Holz | Bois | Wood**

**Ausführungen S. 10**  
Exécutions p. 10  
Executions p. 10  
**10, 80, 82, 93**





**Metall | Métal | Metal**

**Ausführungen S. 9**  
Exécutions p. 9  
Executions p. 9  
**16, 42, 45**



The mark of responsible forestry  
FSC® C123548  
Look for FSC® certified products



				Dimension cm
<b>Trento</b>	 Rahmen Breiten Länge	Cadre Largeurs Longueur	Frame Widths Length	90, 100, 120, 140, 160, 180, 200 200
<b>Tunca</b>	 Füße Höhen	Pieds Hauteurs	Feet Heights	20, 25
<b>Ello</b>	 Kopfteil	Tête de lit	Headboard	90/100, 120, 140, 160, 180/200
<b>Akai</b>	 Nachttisch	Table de nuit	Bedside table	50/41/16

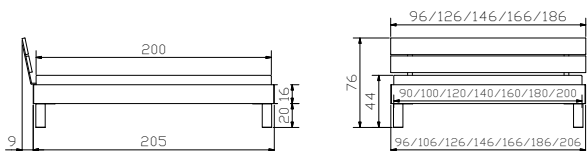

**Alle Holzteile in Buche weiss deckend, lackiert**  
 Toutes les parties en bois en hêtre teinté blanc couvrant, laqué  
 All wooden parts in beech white covered, lacquered





				Dimension cm
<b>Trento</b>	Rahmen Breiten Länge	Cadre Largeurs Longueur	Frame Widths Length	90, 100, 120, 140, 160, 180, 200 200
<b>Roca anthracit</b>	Füße Höhen	Pieds Hauteurs	Feet Heights	20, 25
<b>Lecco</b>	Kopfteil, Kul smoke 336	Tête de lit, Kul smoke 336	Headboard, Kul smoke 336	90/100, 120, 140, 160, 180/200
<b>Salva</b>	Nachttisch	Table de nuit	Bedside table	48/40/35

**Alle Holzteile in Nussbaum, geölt**  
 Toutes les parties en noyer, huilé  
 All wooden parts in walnut, oiled

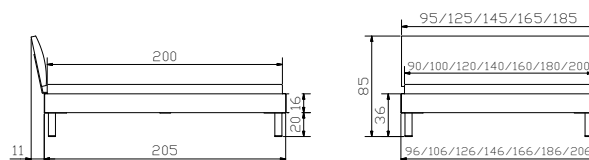



**Erhältlich ohne Kopfteil** | Disponible sans tête de lit | Available without headboard

**Holzteile in Wildeiche natur, geölt, Buche weiss deckend, lackiert und Nussbaum, geölt**  
Parties en bois en chêne noueux naturel, huilé, en hêtre teinté blanc couvrant, laqué et noyer, huilé  
Wooden parts in wildoak natural, oiled, beech white covered, lacquered and walnut, oiled

**Lecco in Kul smoke 336 und Kul white 323**



Lecco en Kul smoke 336 et Kul white 323  
Lecco in Kul smoke 336 and Kul white 323



The mark of  
responsible forestry  
FSC® C123546

Look for FSC® certified products



				Dimension cm
<b>Trento</b>	 Rahmen Breiten Länge	Cadre Largeurs Longueur	Frame Widths Length	90, 100, 120, 140, 160, 180, 200 200
<b>Nelo</b>	 Füße Höhen	Pieds Hauteurs	Feet Heights	20, 25
<b>Lecco</b>	Kopfteil, Kul white 323	Tête de lit, Kul white 323	Headboard, Kul white 323	90/100, 120, 140, 160, 180/200
<b>Akai</b>	 Nachttisch	Table de nuit	Bedside table	50/41/16

**Alle Holzteile in Eiche bianco, geölt**  
 Toutes les parties en bois en chêne bianco, huilé  
 All wooden parts in oak bianco, oiled

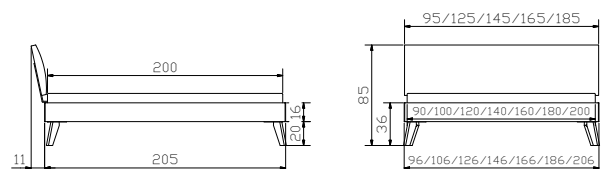



Akai

Nachttisch

Table de nuit

Bedside table

**Dimension cm**

50/41/16

**Alle Holzteile in Wildeiche natur, geölt**

Toutes les parties en bois en chêne nouveau naturel, huilé  
All wooden parts in wildoak natural, oiled





				Dimension cm
<b>Trento</b>	Rahmen Breiten Länge	Cadre Largeurs Longueur	Frame Widths Length	90, 100, 120, 140, 160, 180, 200 200
<b>Tunca</b>	Füße Höhen	Pieds Hauteurs	Feet Heights	20, 25
<b>Pella Lola</b>	Kopfteil Kissen (2er Set), Kul white 323	Tête de lit Coussins (set de 2), Kul white 323	Headboard Cushions (set of 2), Kul white 323	90/100, 120, 140, 160, 180/200 55/35/4

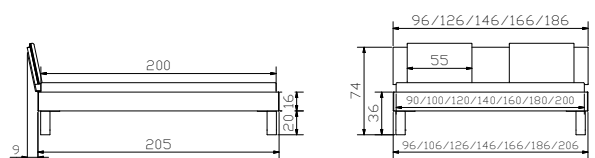



				Dimension cm
<b>Trento</b>	Rahmen Breiten Länge	Cadre Largeurs Longueur	Frame Widths Length	90, 100, 120, 140, 160, 180, 200 200
<b>Tunca</b>	Füße Höhen	Pieds Hauteurs	Feet Heights	20, 25
<b>Pella</b>	Kopfteil	Tête de lit	Headboard	90/100, 120, 140, 160, 180/200
<b>Onia anthracit</b>	Nachttisch	Table de nuit	Bedside table	45/50/41
<b>Unito anthracit</b>	Kommode	Commode	Chest of drawer	45/50/86

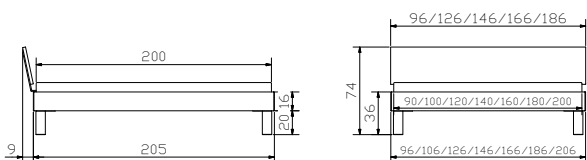

**Alle Holzteile in Kernbuche natur, geölt**  
Toutes les parties en bois en hêtre cœur rouge naturel, huilé  
All wooden parts in heart beech natural, oiled





				Dimension cm
<b>Trento</b>	Rahmen Breiten Länge	Cadre Largeurs Longueur	Frame Widths Length	90, 100, 120, 140, 160, 180, 200 200
<b>Nelo</b>	Füße Höhen	Pieds Hauteurs	Feet Heights	20, 25
<b>Pella</b>	Kopfteil	Tête de lit	Headboard	90/100, 120, 140, 160, 180/200
<b>Dowe anthracit</b>	Nachttisch	Table de nuit	Bedside table	45/50/55

**Alle Holzteile in Nussbaum, geölt**  
 Toutes les parties en bois en noyer, huilé  
 All wooden parts in walnut, oiled

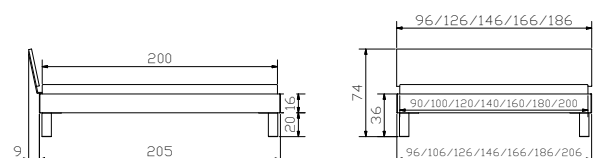



Jose

Nachttisch

Table de nuit

Bedside table

Dimension cm

50/41/36

Roll-Box 20 + 25  
Anthracit | Anthracite



Roll-Box 20 + 25

Wildeiche natur, gebürstet, geölt | Chêne nouveau naturel, brossé, huilé | Wildoak natural, brushed, oiled



The mark of  
responsible forestry  
FSC® C123546

Look for FSC® certified products



				Dimension cm
<b>Trento</b>	Rahmen Breiten Länge	Cadre Largeurs Longueur	Frame Widths Length	90, 100, 120, 140, 160, 180, 200 200
<b>Glyd anthracit</b>	Kufen Breiten Höhen	Patins Largeurs Hauteurs	Vats Widths Heights	140, 160, 180 20, 25
<b>Pella</b>	Kopfteil	Tête de lit	Headboard	90/100, 120, 140, 160, 180/200

**Alle Holzteile in Wildeiche natur, geölt**  
 Toutes les parties en bois en chêne nouveaux naturel, huilé  
 All wooden parts in wildoak natural, oiled

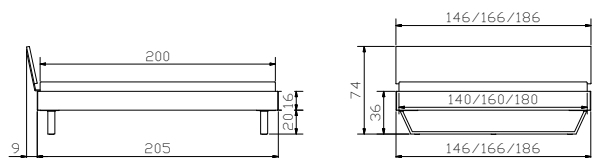



				Dimension cm
<b>Trento</b>	Rahmen Breiten Länge	Cadre Largeurs Longueur	Frame Widths Length	90, 100, 120, 140, 160, 180, 200 200
<b>Nelo</b>	Füße Höhen	Pieds Hauteurs	Feet Heights	20, 25
<b>Ello Lola</b>	Kopfteil Kissen (2er Set), Kul white 323	Tête de lit Coussins (set de 2), Kul white 323	Headboard Cushions (set of 2), Kul white 323	90/100, 120, 140, 160, 180/200 55/35/4
<b>Salva</b>	Nachttisch	Table de nuit	Bedside table	48/40/35

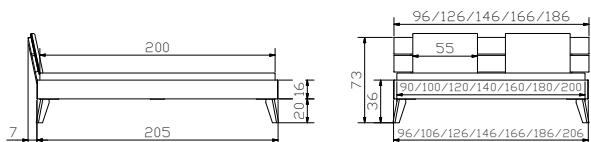

**Alle Holzteile in Wildeiche natur, geölt**

Toutes les parties en bois en chêne nouveau naturel, huilé  
All wooden parts in wildoak natural, oiled



				<b>Dimension cm</b>
<b>Trento</b>	Rahmen Breiten Länge	Cadre Largeurs Longueur	Frame Widths Length	140, 160, 180 200
<b>Nelo</b>	Füsse Höhen	Pieds Hauteurs	Feet Heights	20, 25
<b>Turano</b>	Kopfteil	Tête de lit	Headboard	140, 160, 180
<b>Jaca</b>	Nachttisch	Table de nuit	Bedside table	50/41/42

**Alle Holzteile in Wildeiche natur, geölt**

Toutes les parties en bois en chêne nouveau naturel, huilé  
All wooden parts in wildoak natural, oiled

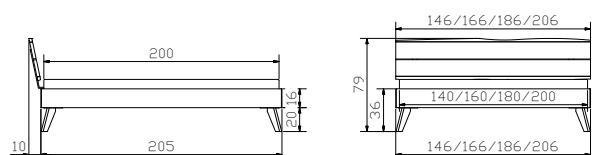



Akai

Nachttisch

Table de nuit

Bedside table

Dimension cm

50/41/16

**Alle Holzteile in Wildeiche natur, geölt**

Toutes les parties en bois en chêne nouveau naturel, huilé  
All wooden parts in wildoak natural, oiled





				Dimension cm
<b>Trento</b>	Rahmen Breiten Länge	Cadre Largeurs Longueur	Frame Widths Length	90, 100, 120, 140, 160, 180, 200 200
<b>Roca iron</b>	Füsse Höhen	Pieds Hauteurs	Feet Heights	20, 25
<b>Pella Lola</b>	Kopfteil Kissen (2er Set), Kul smoke 336	Tête de lit Coussins (set de 2), Kul smoke 336	Headboard Cushions (set of 2), Kul smoke 336	90/100, 120, 140, 160, 180/200 55/35/4

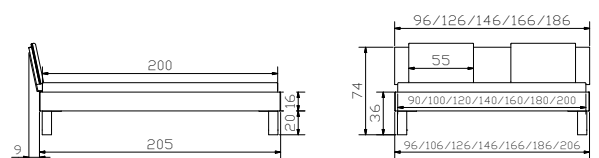



**Akai**

Nachttisch

Table de nuit

Bedside table

**Dimension cm**

50/41/16

**Alle Holzteile in Wildeiche natur, geölt**

Toutes les parties en bois en chêne nouveau naturel, huilé  
All wooden parts in wildoak natural, oiled



				Dimension cm
<b>Trento</b>	Rahmen Breiten Länge	Cadre Largeurs Longueur	Frame Widths Length	90, 100, 120, 140, 160, 180, 200 200
<b>Tondo anthracit</b>	Füße Höhe	Pieds Hauteur	Feet Height	20

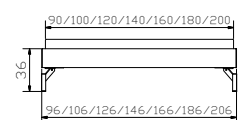
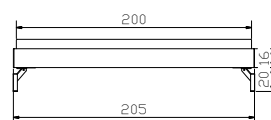



**Onia** anthracit  
**Jone 10** anthracit

Nachttisch  
Füsse

Table de nuit  
Pieds

Bedside table  
Feet

**Dimension cm**

45/50/41  
10

**Stoffauswahl** | Choix de tissus | Selection of tissues



**335 Pepe grey**  
100 % Polyester



**336 Kul smoke**  
50 % Baumwolle | Coton | Cotton  
50 % Polyester

**Stoff Kul smoke 336** | Tissu KUL smoke 336 | Tissue KUL smoke 336

**Alle Holzteile in Wildeiche natur, geölt**

Toutes les parties en bois en chêne nouveau naturel, huilé  
All wooden parts in wildoak natural, oiled



				<b>Dimension cm</b>
<b>Pietro</b>	Bettgestell inkl. Kopfteil	Bois de lit, tête de lit incluse	Bed frame, headboard included	
	Breiten	Largeurs	Widths	140, 160, 180
	Länge	Longueur	Length	200
	Fusshöhen	Hauteurs de pieds	Heights of feet	20, 25

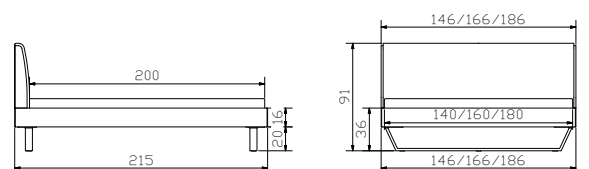



<b>Jaca</b>	 Nachttisch	Table de nuit	Bedside table	<b>Dimension cm</b> 50/41/42
-------------	--	---------------	---------------	---------------------------------

**Stoff Kul smoke 336** | Tissu Kul smoke 336 | Tissue Kul smoke 336

**Holzteile in Kernbuche natur, geölt** | Parties en bois en hêtre coeur rouge naturel, huilé | Wooden parts in heart beech natural, oiled

**Akai**



**Jaca**



**Stoffauswahl** | Choix de tissus | Selection of tissues



**335 Pepe grey**  
100 % Polyester



**336 Kul smoke**  
50 % Baumwolle | Coton | Cotton  
50 % Polyester



				Dimension cm	
<b>Simone</b>		Bettgestell inkl. Kopfteil	Bois de lit, tête de lit incluse	Bed frame, headboard included	
		Breiten	Largeurs	Widths	140, 160, 180
		Länge	Longueur	Length	200
		Fusshöhen	Hauteurs de pieds	Heights of feet	20, 25
<b>Akai</b>		Nachttisch	Table de nuit	Bedside table	50/41/16
<b>Dowe anthracit</b>		Nachttisch	Table de nuit	Bedside table	45/50/55
<b>Atrine anthracit</b>		Kommode	Commode	Chest of drawer	90/50/86

**Stoff Pepe grey 335 und Kul smoke 336** | Tissu Pepe grey 335 et Kul smoke 336 | Tissue Pepe grey 335 and Kul smoke 336

**Holzteile in Kernbuche natur, geölt oder Nussbaum, geölt** | Parties en bois en hêtre coeur rouge naturel, huilé ou noyer, huilé | Wooden parts in heart beech natural, oiled or walnut, oiled

